

*Always Committed to Quality, Technology & Innovation*

## **ES-8A Digital Readout System Operation Manual**



# Content

<b>Safety Notice.....</b>	<b>I</b>
<b>Introduction.....</b>	<b>II</b>
<b>Installation.....</b>	<b>II</b>
<b>1. Basic Functions .....</b>	<b>01</b>
<b>2. Built in Calculator .....</b>	<b>08</b>
<b>3. 199 Sub Datum Function .....</b>	<b>12</b>
<b>4. REF Datum Memory .....</b>	<b>20</b>
<b>5. LHOLE Function .....</b>	<b>24</b>
<b>6. INCL Function .....</b>	<b>28</b>
<b>7. PCD Function .....</b>	<b>33</b>
<b>8. ARC Function .....</b>	<b>38</b>
<b>9. Simplified R Function .....</b>	<b>56</b>
<b>10. Shrinkage Calculation Function ....</b>	<b>66</b>
<b>11. Lathe Application Supplement .....</b>	<b>A.1</b>
<b>12. Parameters Setup .....</b>	<b>B.1</b>
<b>13. Scale Installation Manual .....</b>	<b>C.1</b>

# Warning and key points

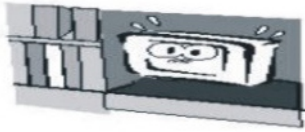

Install the display with double-screw bolt and fix it on a stable position, or the display will decline and be damaged, even catch fire.



Do not put the display near water or oil etc, or it will be at the risk of catching fire.



Do not use damaged power patch plug and put the power cable near the heat sources, or it will evoke electric shock or fire.

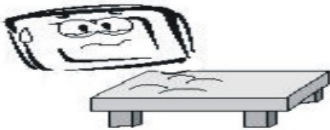

Put the display on balanced plane, or it will decline even to be damaged.



Ensure the power plug is in good grounding before installation, or it may evoke electric shock or fire.

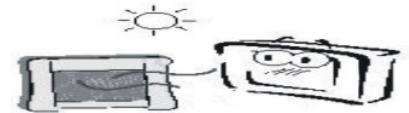

Do not use the display in the direct sunlight, and keep it away from heat source such as heater or baker, or the display may catch fire.

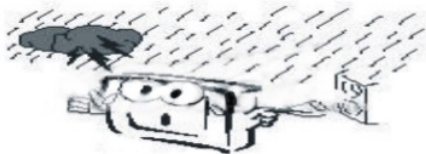

Do not use the display in rainstorm or thunder days, and pull out the power plug.



Do not parallel excessive slots and connect overfull plugs in a socket together, or it will catch fire due to overmuch power-dissipation.



Do not disassemble the display by yourself, if there is any fault, ask the professional for help to repair it. If you dismantle it by yourself, it may cause electric shock or fire.



Make sure the plug is in good electric contact, because the faulty contact will cause fire.



Pull out the power plug before washing with soft rag, do not use industrial chemical pharmaceuticals. And keep water outside of the display.

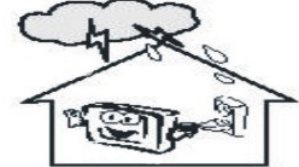

During rainstorm or thunder, please switch off the power, or it will evoke electric shock or fire.

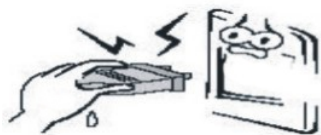

Do not use the plug when your hands are wet, or it will cause electric shock.



If the plug or input cable is dirty, clean them immediately, or it will cause electric shock or fire when you use them.



If you don't use the display during a long period, please cut off the power, or it will cause electric shock or fire.



Switch off the power immediately and ask for repairing if there is awful odour or abnormal sound.



Do not use or store combustibles nearby the display, or it will evoke explosion or fire.

**➤ Read the notice above before installation. The product has to be installed by professionals.**

**ATTENTION: To avoid possible Electrical Shock !!**

The DRO's Main Earth through the 3 core plug flex must be connected to Earth(ground), either directly through the plug supplied or through the machine it is fitted to. If hard wired, the power to the DRO must be protected by the Earth Leakage Circuit Breaker.

A separate "Static" Earth also needs connecting from the Earth point on the rear of the DRO to the machine body(for measurement accuracy).

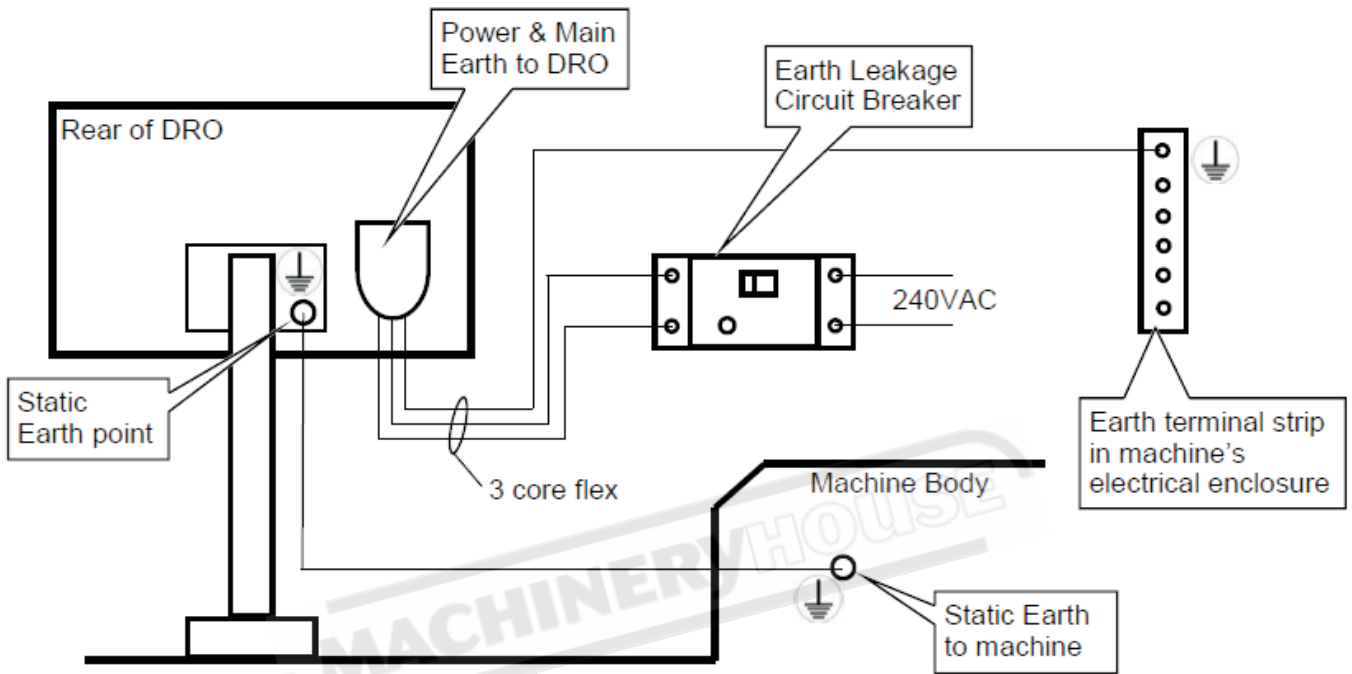

**Fitting the Static Earth**

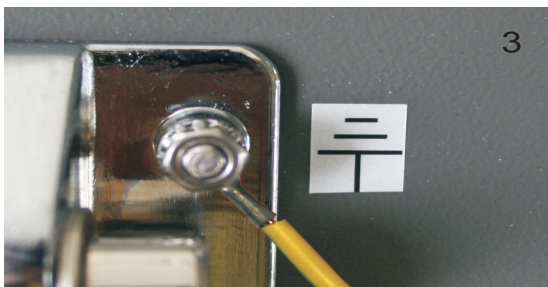
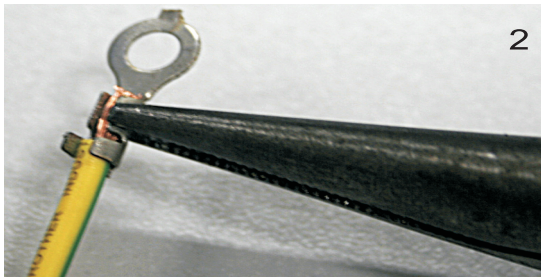
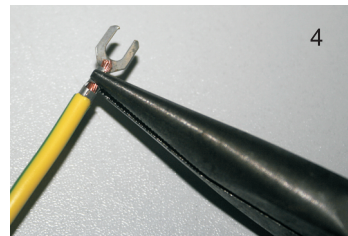



# SPECIFICATIONS

## 1.1 SPECIFICATIONS :

Operation Voltage:	115 / 230V AC
Supply Voltage Fluctuation:	Not to exceed $\pm 10\%$ of the operating voltage
Supply Frequency:	50 - 60Hz
Max Power Consumption:	20 VA
Operating Temperature:	0 °C - 45 °C ( 32 °F - 113 °F )
Operating Relative Humidity:	$\leq 95\%$ (45 °C $\pm 2$ °C )
Storage Temperature:	-40 °C - 55 °C ( -40 °F - 131 °F )
Storage Relative Humidity:	$\leq 95\%$ (45 °C $\pm 2$ °C )
Inputs:	Depend on model, 2, 3 or 4 Linear Transducers

**\*\* we reserve the right to change the specifications as listed in above without any prior notice. \*\***

### EMC compliance

The DRO have been to conforms to relevant standards for electromagnetic compatibility ( EMC ) as detailed below.

**IEC 61000-6-2** : Electromagnetic compatibility, Generic Immunity Standard - Industrial Environment.

**IEC 61000-6-4** : Electromagnetic compatibility, Generic Emission Standard - Industrial Environment.

**EN 61000-6-2** : Electromagnetic compatibility, Generic Immunity Standard - Industrial Environment.

**EN 61000-6-4** : Electromagnetic compatibility, Generic Emission Standard - Industrial Environment.

**GB/T 17799-2** : Electromagnetic compatibility, Generic Immunity Standard - Industrial Environment.

**GB/T 17799-4** : Electromagnetic compatibility, Generic Emission Standard - Industrial Environment.

### MOUNTING & INSTALLATION

#### 2.1 MOUNTING

Select the location of the installation with due regard of safety and ease of operation. Keep the DRO away of moving parts and coolant spray. To ensure correct operation of the DRO , make sure that the DRO is correct grounding. Grounding diagram is as shown in SAFETY NOTICE.

The DRO can be mounted on 4 different arm stand brackets as per detailed on the Optional Accessories List. As shown in Figure 2.1:

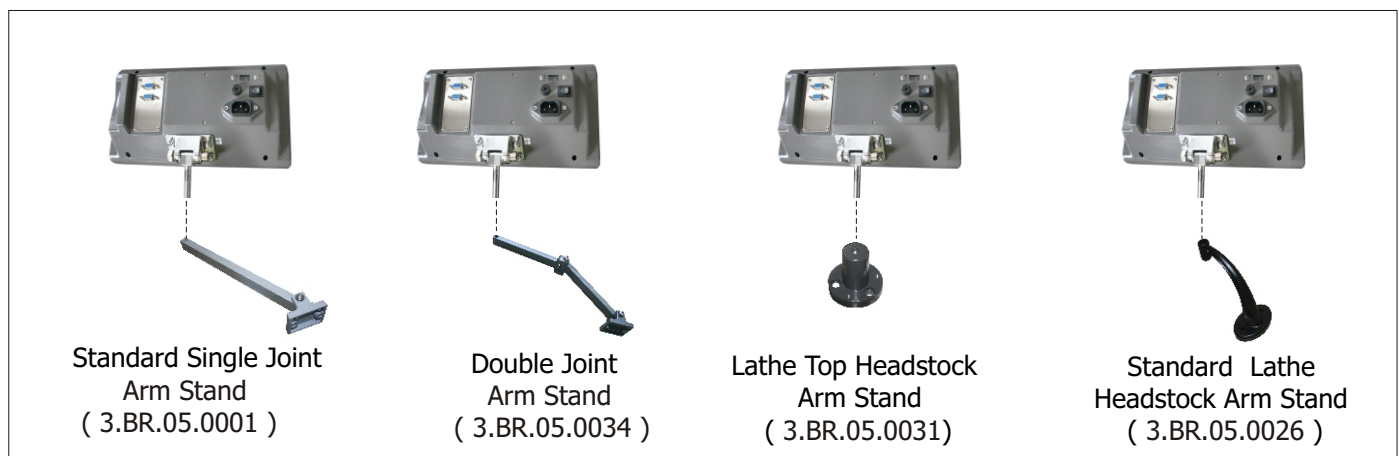

**Figure 2.1 Mounting of the DRO**

# POWER SUPPLY CONNECTION

## 2.2 POWER SUPPLY CONNECTION

**Before connecting the electrical supply to the DRO, please check the VOLTAGE SELECTOR switch to see if correctly main supply voltage selected or not. Check Figure below for the position of the switch.**

The **PROTECTIVE EARTH CIRCUIT** of the mains supply **MUST BE CONNECTED** to the earth grounding terminal of the DRO through the supply cord **and** connected through an earth cable as per shown in Page 1.

The supply cord must be secured with cable ties to avoid from dropping into a hazardous position, for example the floor or coolant tray, when disconnected from the DRO.

The supply cord must be routed away from moving parts, swarf, coolant or sources of heat.

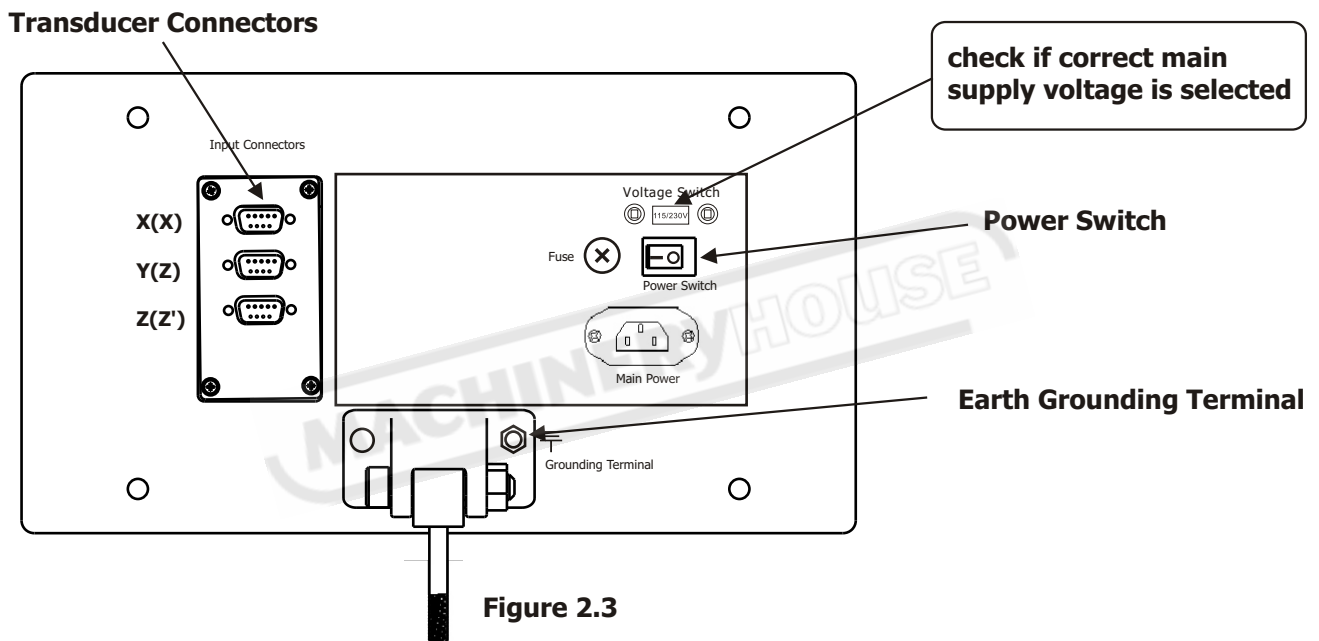

If a mains plug is not already fitted to the supply cord or is of the wrong type, then a suitable EARTHED plug should be used which complies with the relevant specifications for plugs and socket-outlets.

The specification of the mains supply fuse is **T0.5A, 220V**. It can not be replaced by operator. If the fuse blows it is a possible indication of some significant problem with the power source.

Check the supply and wiring carefully. When replacing the fuse, the DRO must be first disconnected by removal of the IEC socket from the inlet. For this connector is the primary disconnect device, do not place the DRO in the place where is difficult to reach and make sure that the plug must be accessible all the time.

- NOTE: 1. If the DRO is used in a manner not specified by the manufacturer, the protection provided by the equipment may be impaired.**
- 2. Non-professionals do NOT open the cover or repair**

### 2.3 LINEAR TRANSDUCER CONNECTION

Connection sockets as shown in Figure 2.3. The transducers are connected to the DRO with 9-pin DB Type connectors.

Switch off the DRO before connecting or disconnecting the linear transducers. To fit the connectors into the appropriate socket on the back of the DRO, first align the connector and then push firmly in place. And secure with the screws. To remove the connectors, loosen the screws and pull the connector clear.

### 2.4 SWITCHING ON

Find the power switch as shown in Figure 2.3.

When the operators switch on the DRO, the DRO will automatically go through a brief self diagnostic routine.



# Basic Functions

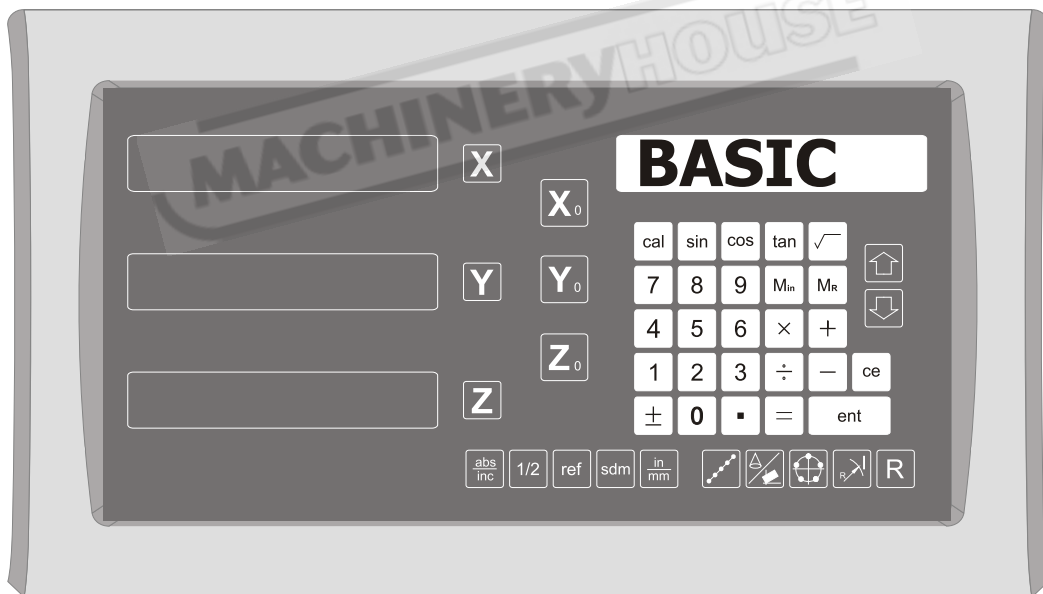

---

## Basic Functions - Set display to ZERO

---

**Purpose :** Set the current position for that axis to ZERO

**Example :** To set the current X axis position to ZERO

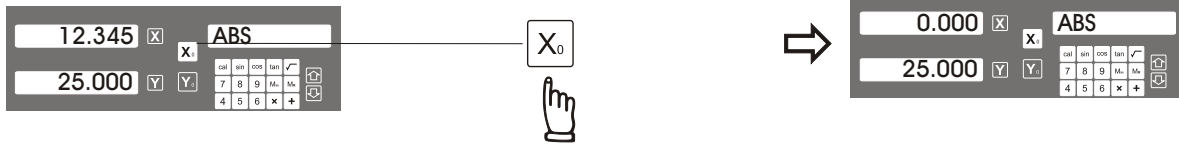

---

## Inch / Metric display conversion

---

**Purpose :** Switches between Inch and Metric display

**Example 1 :** Currently in Inch display, to swap to Metric display

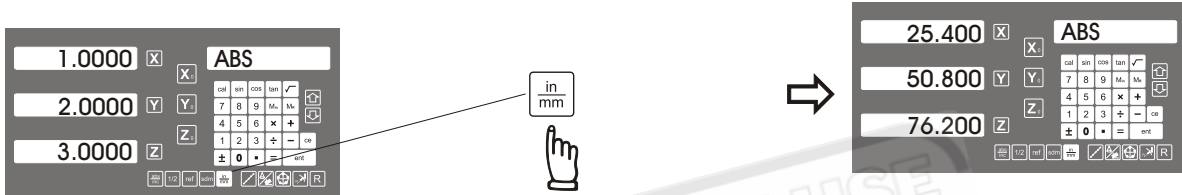

**Example 2 :** Currently in Metric display, to swap to Inch display

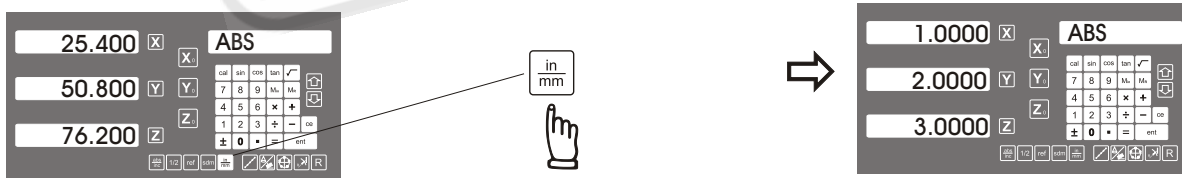

---

## Enter Dimensions

---

**Purpose :** Set the current position for that axis to an entered dimension

**Example :** To set the current X axis position to 45.800mm

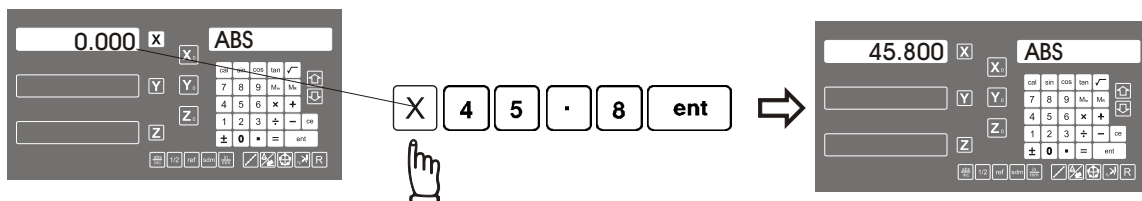



## Basic Functions - Centre Find

**Purpose :** ES-8A provides centre find function by halving the current display coordinate, so that the zero position of the work piece is located at the centre of the work piece.

**Example :** To set the current X axis zero position at the centre of the work piece

**Step 1 :** Locate the edge finder at one end of the work piece, then zero the X axis.

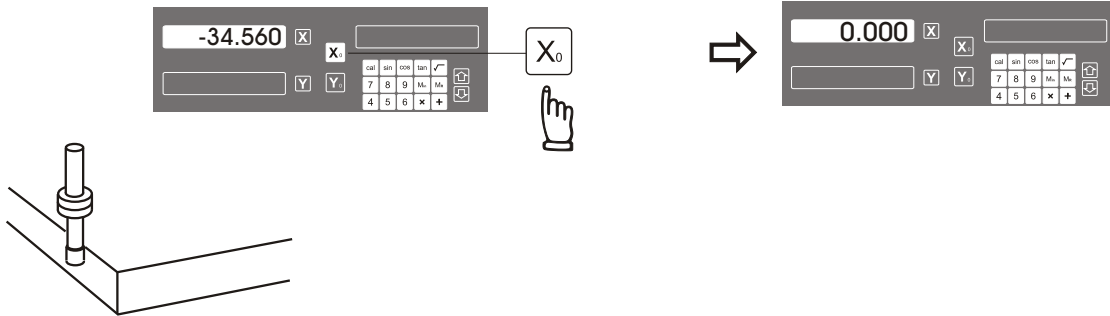

**Step 2 :** Located the edge finder at the opposite end of the work piece.

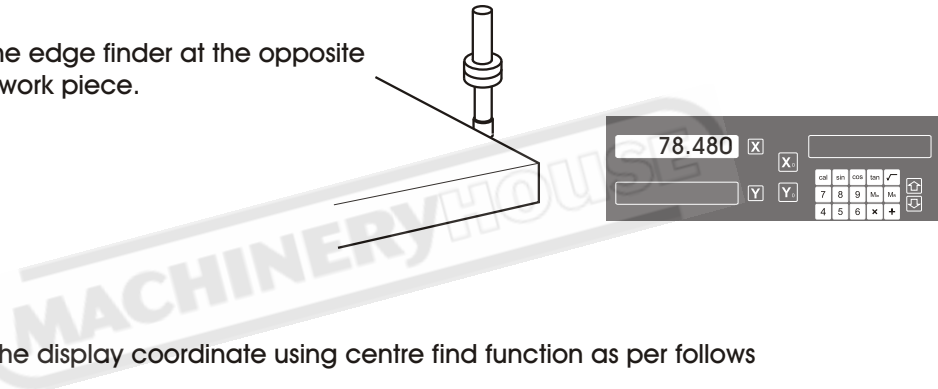

**Step 3 :** Then half the display coordinate using centre find function as per follows

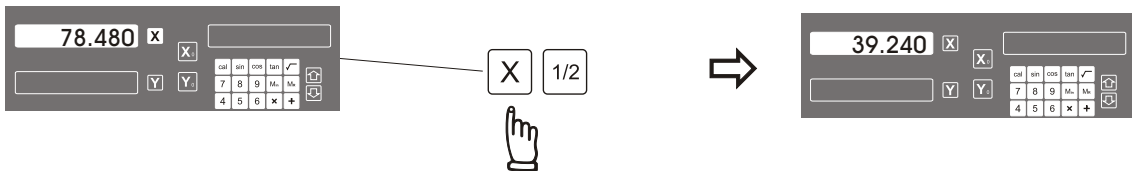

Now the X axis zero position ( 0.000 ) is located right at the X centre of the work piece



## Basic Functions - ABS/INC coordinate display

**Purpose :** ES-8A provides two sets of basic coordinate display, they are **ABS** ( absolute ) and **INC** ( incremental ) displays.

During machining operations, operator can store the work piece datum ( ZERO position ) in **ABS** coordinate, then switch to **INC** coordinate to continue machining operations

Then the operator is free to zero the axes or preset any dimensions into any axis in **INC** coordinate for any relative position machining. The work piece datum ( work piece ZERO position ) is still keep in ABS coordinate of the DRO.

Operator can switches between **ABS** ( absolute ) and **INC** ( incremental ) coordinate without losing the work piece datum ( work piece zero position ).

**Example 1 :** Currently in **ABS** display coordinate, to switch to **INC** display coordinate

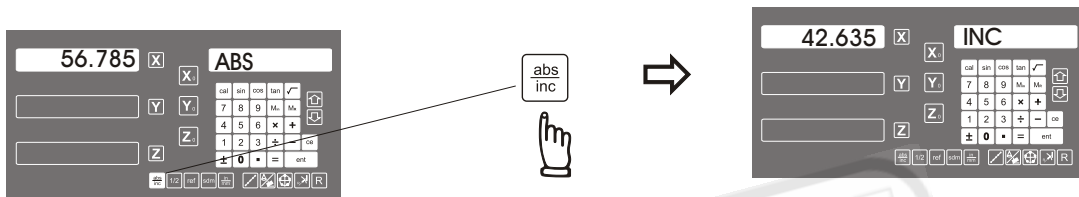

**Example 2 :** Currently in **INC** display coordinate, to switch to **ABS** display coordinate

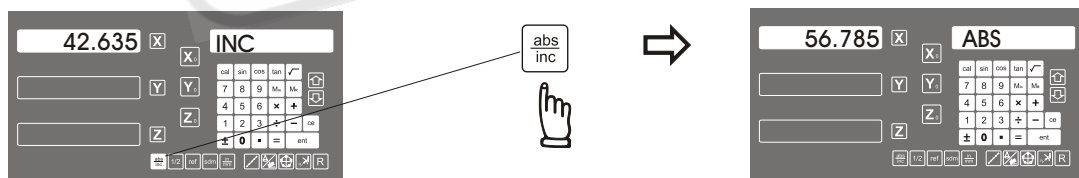

## Basic Functions - SPEED [ axial cutting speed display ]

Purpose : To make sure the machining surface finished is consistent, operator must know exactly how much the machine travel speed is for the machining ( such as cutting, facing and etc.. ).

ES-8A provides the SPEED function to display the machine moving speed in **mm/min** in all selected axis. The SPEED display is filtered by an 0.25 sec display filter to provide stabilized speed display, to enable the operator to adjust the machine's power feed at a more easy and comfortable speed visualization.

The display resolution of the SPEED function is in **mm/min**, which is the most commonly used unit in machine feed rate in CNC machining or cutting tool feed calculations. SPEED function is very useful in monitoring many common machining process ( such as cutting, facing and etc.. ) to achieve predictable surface finish or to achieve predictable cutting tool life.

Example : To activate the SPEED display of X Axis, press  Axis button for more than 0.6 sec. Then the X moving speed display will be displayed in message window. Same operation for Y, Z and U axis.

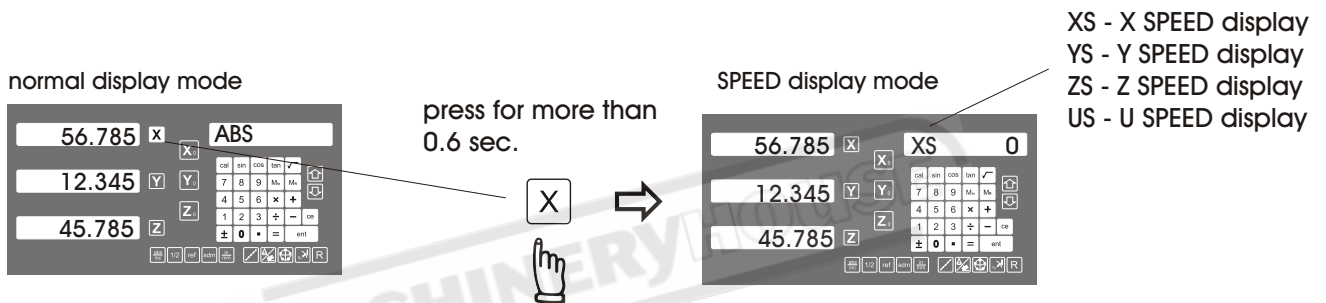

*Please notice that during the SPEED display mode, all DRO functions are temporarily disable ! Operator have to exit the SPEED display mode to carry out any normal DRO functions*

To exit the SPEED display mode and return to normal display mode, press 

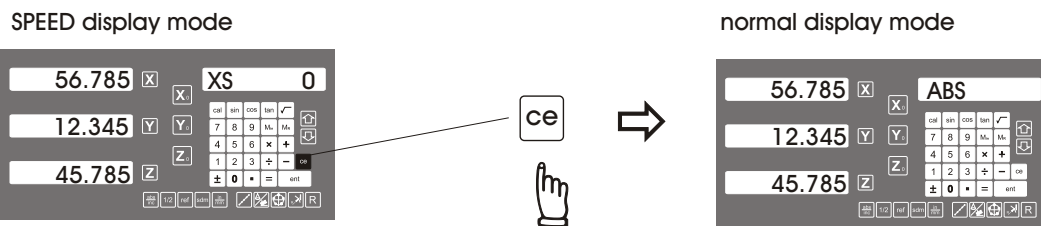

## Basic Functions - Vibration Filtering

Purpose : Vibration filtering is especially useful for old and big machines in which the machine structure is not rigid enough to get a stable display during machining or moving. when the machine is moving or machining in one axis, the other axes may vibrate and hence the DRO display numbers are jumping around which may cause confusions and uncomfortable position visualization to the operator.

ES-8A provides vibration filtering function to stabilize the digits display, it make the operator more comfortable during the position visualization. Filtering bandwidth parameter can be set in SETUP procedure to adopt the different condition of the machine.

To have the most sensitive display for manual machine positioning, it is advisable that the operator to cancel any vibration filtering to get the most sensitive and fastest response position display to make the manual machine positioning more comfortable to operate. When the machine is moving by the power feed or making the parts cutting, it is prefer that to put the vibration filter on to have more comfortable position readings visualization.

Therefore, ES-8A provides easy swap between filtered and non-filtered displays by just a simple key button press !

Example : To activate the vibration filter, press **ce** button for more than 0.6 sec.

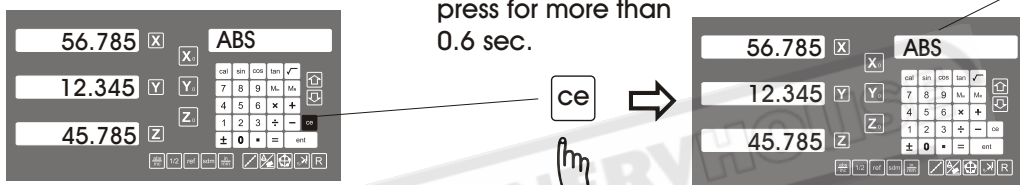

When Vibration filter is on, the LEFT more digit of the message window will flashing to indicate vibration filtering is ON.

To cancel the vibration filter, press **ce** button for more than 0.6 sec again.

When Vibration filter is on, the LEFT more digit of the message window will flashing to indicate vibration filtering is ON.

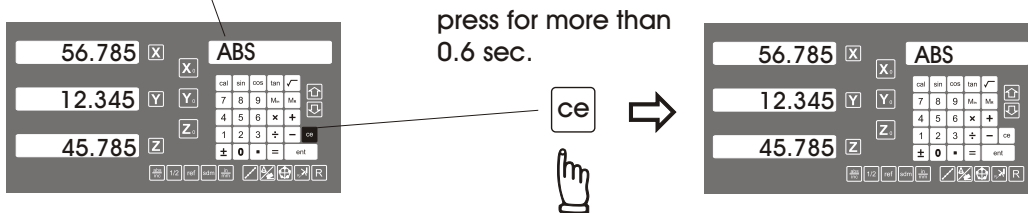

*please notice that the vibration filter won't affect the accuracy of the position display, it cannot make the DRO display reading more accurate or less accurate !!*

## Basic Functions - XZ/YZ Axes Summing

This function available only when the 3 Axes DRO configured to DRO TYPE = LATHE

**Purpose :** The Axes Summing function is a useful function for LATHE application.

ES-8A provides the axes summing function for providing temporarily summing display of XZ and YZ axes, operator can swap back to the original displays ( X/Y/Z individual display with no summing of axes ) at any time they want.

The summing function is useful when two linear scales are installed on the cross slide of lathe. The summing function allow the operator to have direct combined reading of these two linear scales for the tool tip positioning, this make machining more easier and less mistake.

**Example :** To get the summing display of X and Z axes  
 ( the same operation if we want summing the Y and Z axes, if we want YZ summing, just replacing the X axis button key press with Y axis button key press as per following example. )

enter the Z axis function

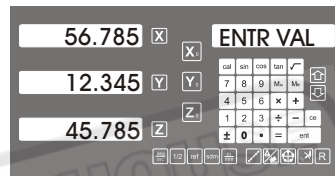
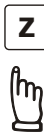
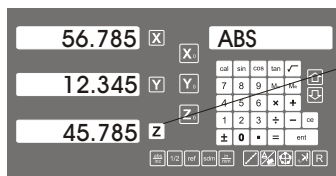

press X axis button key

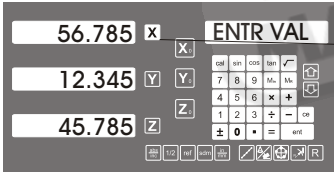

Axes summing display

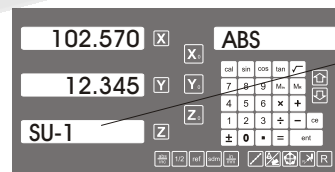

SU-1: Summing axis 1( X )  
 SU-2: Summing axis 2( Y )

In the axes summing display mode, the Z axis will turn off to avoid possible confusion to the operator. Message "SU-1" or "SU-2" to let the operator know which axis have summed with Z axis.

*Please notice that when the display is in axes summing mode, all DRO functions are temporarily disabled to avoid confusion and mistaken operation !!*

To exit from Axes summing display mode, return to normal X/Y/Z display, press ce

Axes summing display

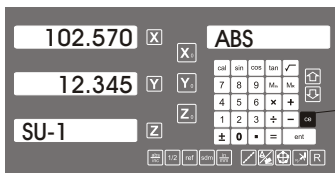

normal X/Y/Z display mode

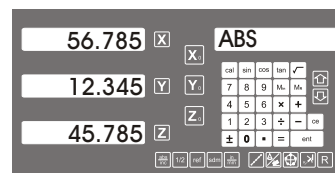



# Built in Calculator

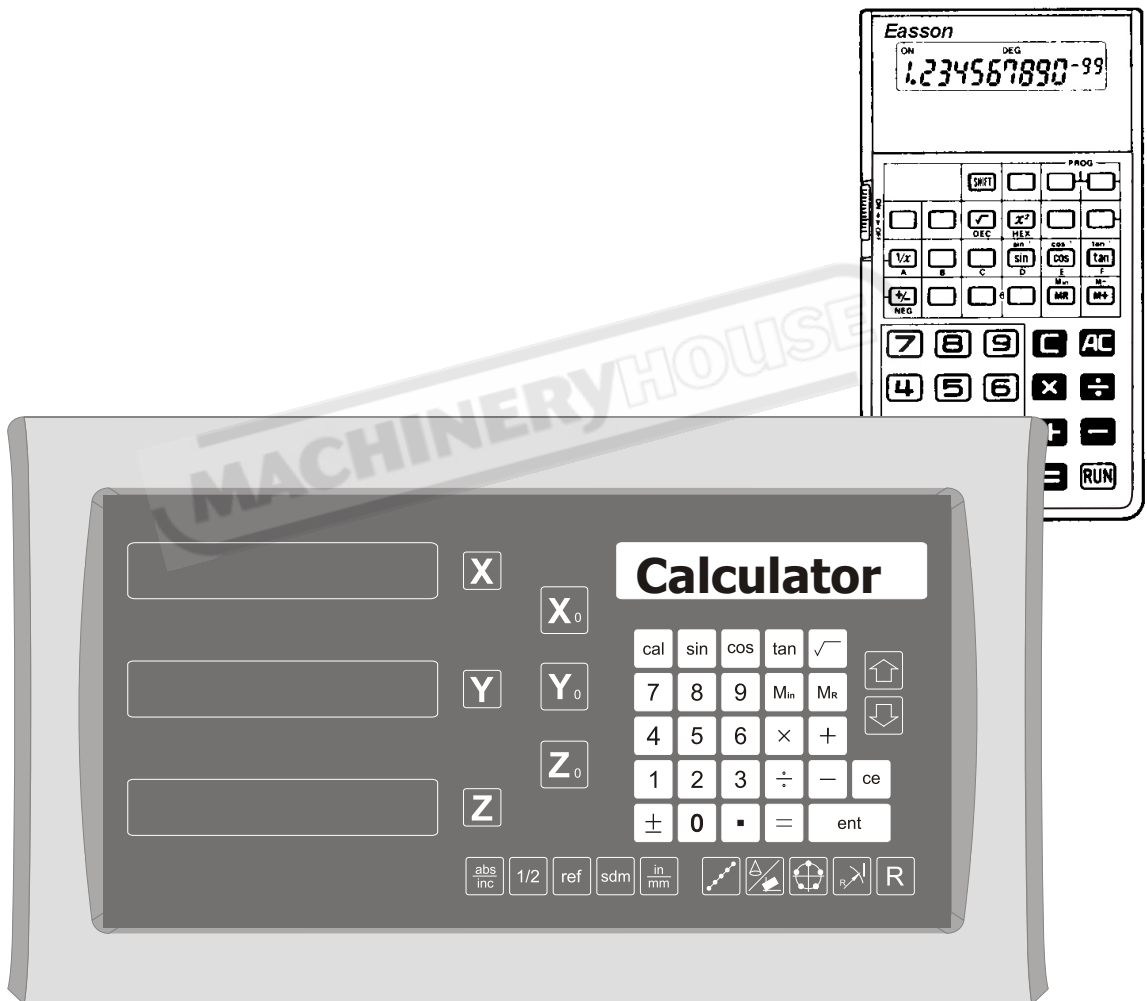

---

## Built in Calculator

---

**Function :** Calculator is the most frequently use tool during the manual machining process.

ES-8A provides a built-in calculator which can perform normal mathematical calculations such as add, subtract, multiply, division and etc., it also provides useful trigonometric calculations that are frequently used during machining process, such as SIN, COS, TAN, SQRT, and also their inverses, such as inv SIN, inv COS, inv TAN, SQUARE...

The built in calculator of this DRO also provides the "result transfer" function, all calculated result can "transferred" to any axis, the DRO temporarily preset the axis's zero position at the calculated result coordinate, operator simply move the machine to axis display = 0.000, then the tool is located at the calculated value. This preset is only temporarily, after the operator finished the machine operation at the calculated coordinate, he can simply press CE key, then the axis's zero position will be resumed to the original coordinate before the "result transfer", the operator can continue the remaining machining as normal.

*The built-in calculator offers following advantages :*

1. Operations are same as normal commercially available calculators, easy to use and no need to learn.
2. Calculated result can be transferred to any axis directly, no need to mark down the calculated number on paper or etc., it is more convenience, time saving and less mistake.
3. No unnecessary down time in finding or sharing the calculators whenever you need one for mathematical calculation.

---

### Result transfer key

press this key to transfer calculated result on to the axis display, then the DRO will temporarily preset the axis's zero at calculated value, operator just move the machine until axis display = 0.000, then the calculated position is reached.

### Calculator key

key to enter into calculator function

### Calculated result display

### Inverse key

for the inversed trigonometric calculation

### Clear key

1. clear key in normal calculation mode
2. cancel the result transfer's temporarily zero preset

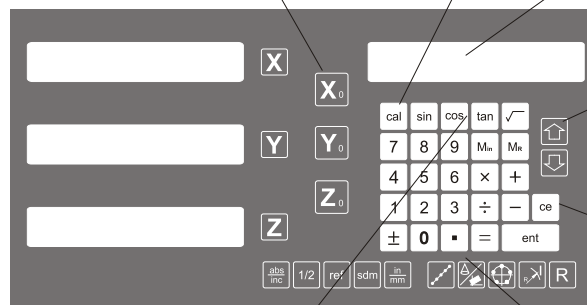

### trigonometric functions keys

### Calculator Keypad

Key layout of the built in calculator

## Built in Calculator

Example :

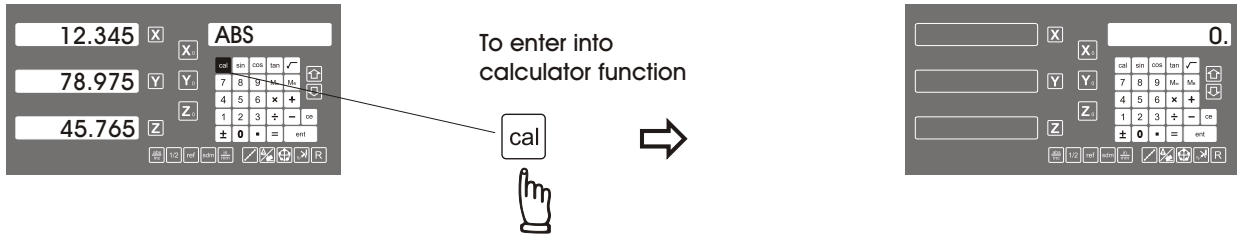

The operations of the DRO's built-in calculator is same as common commercially available calculator

i.e. Basic mathematics - **add ; subtract** :  $78 + 9 - 11 = 76$

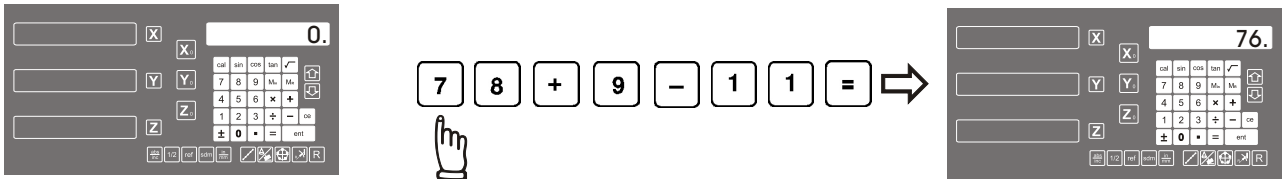

**Clear & restart the calculation**

since this DRO don't have AC key as per normal calculator, therefore, CE key is used to act as the AC key in normal calculator

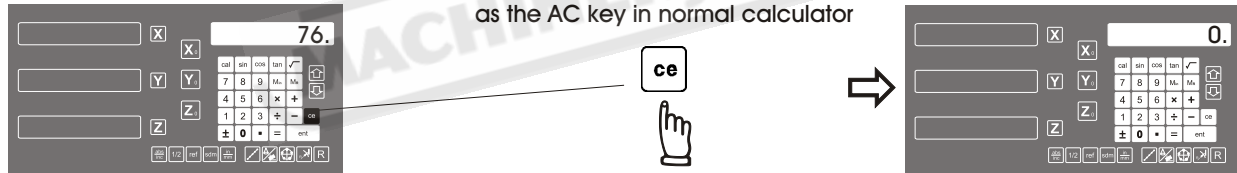

i.e. Basic mathematics - **multiply ; division** :  $78 \times 9 / 11 = 63.81818$

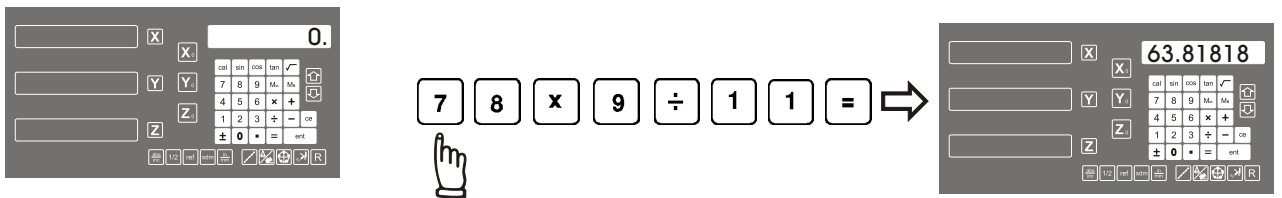

i.e. Trigonometric calculation - **COS** :  $100 \times \text{COS } 30^\circ = 86.602540$

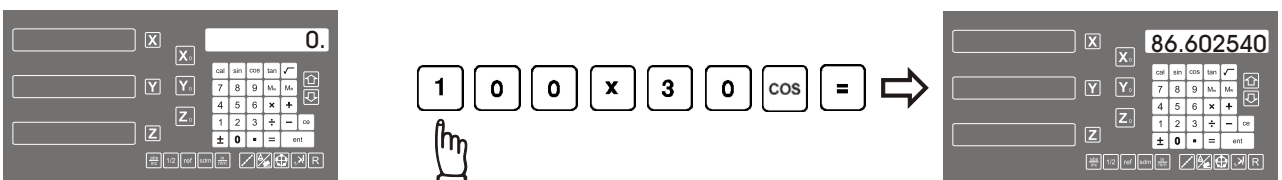

## Built in Calculator

**i.e. Trigonometric calculation - inverse SIN :  $\text{SIN}^{-1} 0.5 = 30$**

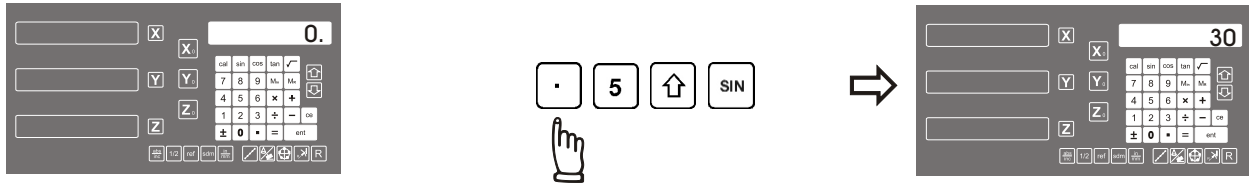

### Result transfer

**i.e. To move the tool at the X axis position :  $105 \times 1.035 = 108.675$**

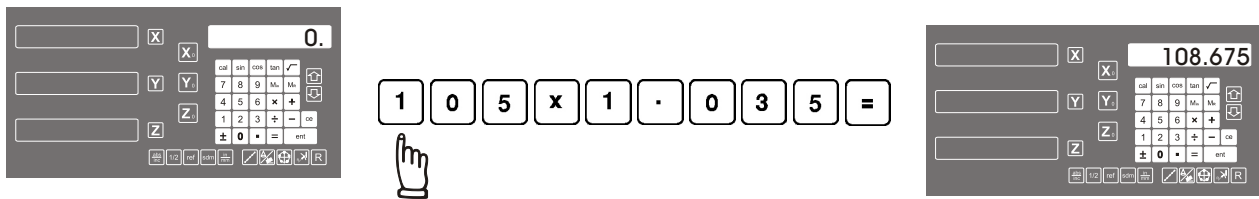

transfer the calculated result : 108.675  
to X axis for tool positioning

X axis zero position is now  
temporarily preset at X = 108.675

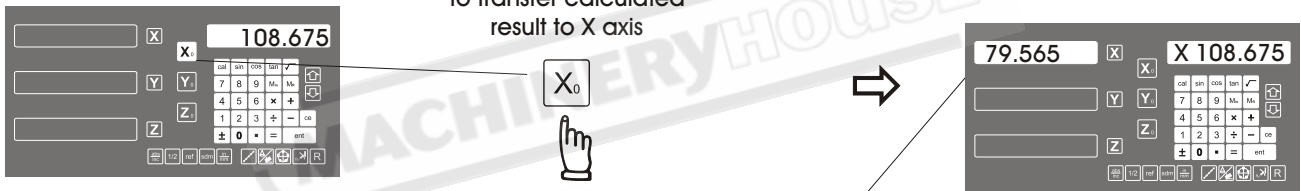

move the machine to X display = 0.000  
then the tool is located at the position  
of X = 108.675

digit display shift left  
to identify X axis is  
at positioning mode



*Tool is now at the position of calculated result,  
( X = 108.675 in the above example )  
press the CE key to return to the normal  
display coordinate*

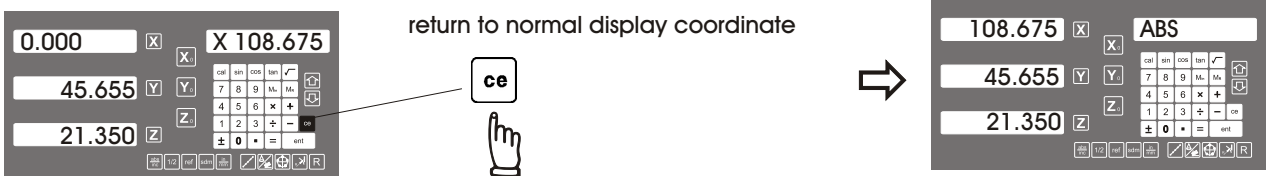

---

# 199 Subdatum Function

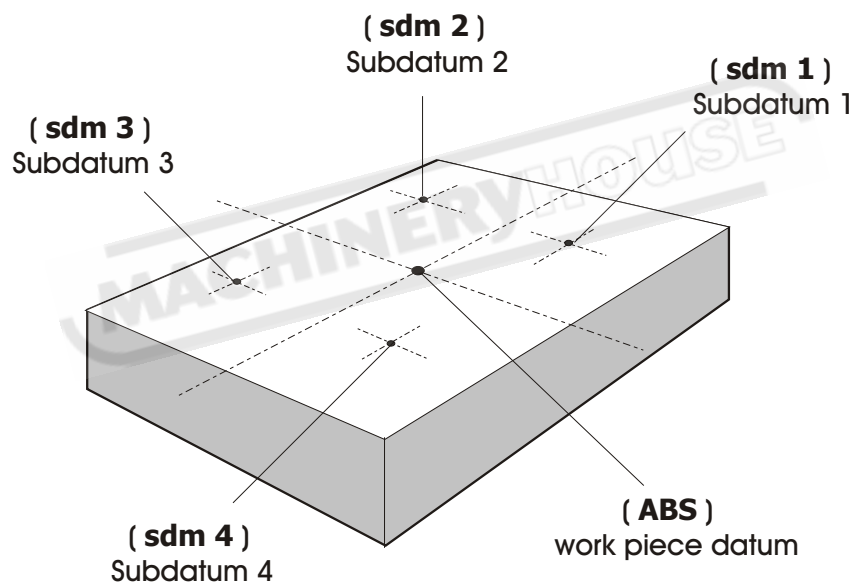



## 199 Subdatum Function - working principal

**Purpose :** Most commonly available DROs in the market are just provide two set of work coordinates - ABS/INC, however, it was found that in case of a bit more complicated machining or in the small batch machining of repetitive parts, only the ABS/INC coordinate are not adequate for providing efficient and convenient tool positioning for the machining.

Shortfalls of having only ABS/INC coordinates are as follows

- In many machinings, the work piece machining dimensions are come from more than two datums, therefore, operator has to switch between ABS and INC to set up extra machining datums times after times, this is time consuming and easily make unnecessary mistakes.
- In case of batch machining of repetitive parts, operator has to set up and calculate all machining positions repeatively, again, it is time consuming and not efficient !

ES-8A provides extra 199 subdatums ( sdm ) memory to overcome the above shortfalls of having only the ABS/INC coordinates, sdm function not just simply provide 199 set of extra INC coordinates, it is specially designed to provide very useful and convenient operations to operator for repetitive batch machining. *Followings are the difference between INC and SDMs.*

- 1. INC is independent of ABS, it won't follows any change in ABS datum ( zero point ) . However, all sdm coordinates are relative to ABS coordinate, all sdms position are relative to ABS's zero, it will shift together with ABS zero position changes.**
- 2. All sdms coordinate's relative distance to ABS can be entered directly into the DRO using the keypads. No need of any calculation or actual tool positionings inthe machine.**

### sdm application in the work piece that have more than on datums

operator can store all work subdatums in the DRO's memory as per follows

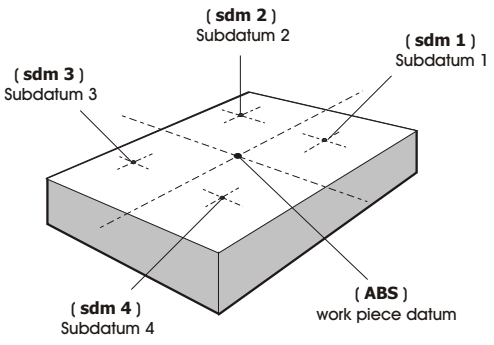

( sdm 2 )  
Subdatum 2

( sdm 1 )  
Subdatum 1

( sdm 3 )  
Subdatum 3

( sdm 4 )  
Subdatum 4

( ABS )  
work piece datum

operator then can switch between the subdatums directly by press UP or DOWN keys, no need to refer back to ABS coordinate and set up the subdatums from their relative distance from ABS

sdm 2

↑  
or  
↓

↑  
or  
↓



### sdm application in batch machining of repetitive works

since all sdm subdatums ( 0.000 ) are relative to ABS zero, therefore, for any repetitive works, the operator just needs to set up the first work piece zero at ABS, store all the machining positions as the subdatum zero in one of the 199 subdatum memory.

For anymore repetitive parts, just set up the 2nd, 3rd, 4th,.. etc.. work piece zero at ABS, then all the machining positions will reappear in the subdatums zero positions.

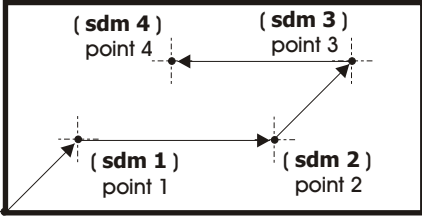

( sdm 4 ) point 4

( sdm 3 ) point 3

( sdm 1 ) point 1

( sdm 2 ) point 2

( ABS )  
work piece datum ( 0.000 )

press UP or DOWN keys to go to machining points

or

move the machine to display = 0.000, then tool is posited at the machining positions.

0.000

sdm 2

↑  
or  
↓

↑  
or  
↓

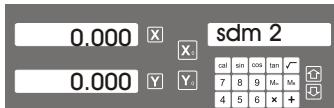

# 199 Subdatum Function

## Application example :

To set up the following four subdatum zero ( SdM 1 to SdM 4 ) as follows, followings two methods can be used.

1. move the machine directly to required subdatum positions, then zero SdM display coordinate
2. directly key in the sdm zero position coordinate ( coordinate relative to ABS zero )

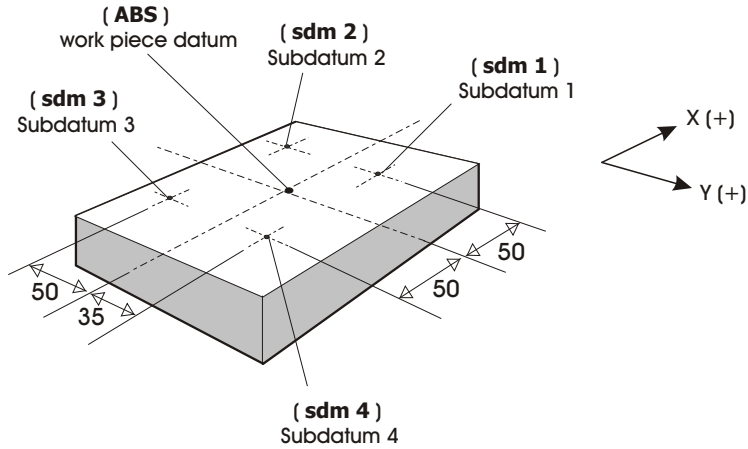

### Method 1 : move the machine to required subdatum position, then ZERO SdM display coordinate

Set up the work piece datum in ABS coordinate, then move the machine to required subdatum position, then ZERO SdM display coordinate accordingly

#### Step 1: setup the work piece datum in ABS coordinate

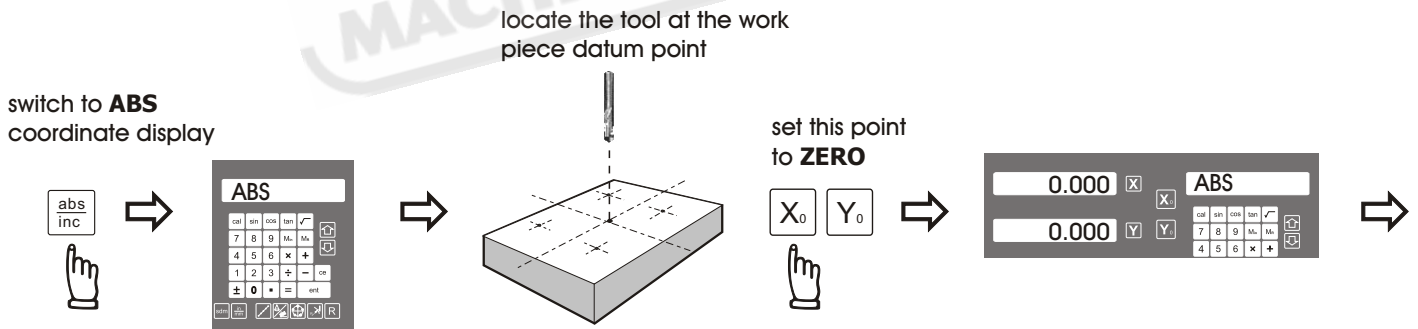

#### Step 2: setup the subdatum point 1 ( sdm 1 )

locate the tool at subdatum point 1 ( sdm 1 )  
**X=50.000 , Y=35.000**



## 199 Subdatum Function

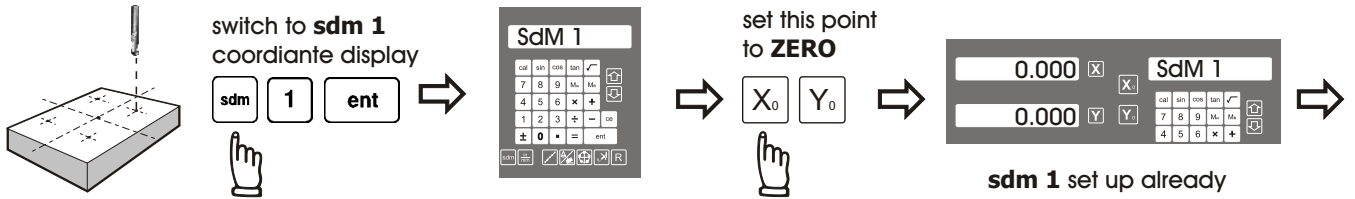

### Step 3: setup the subdatum point 2 ( sdm 2 )

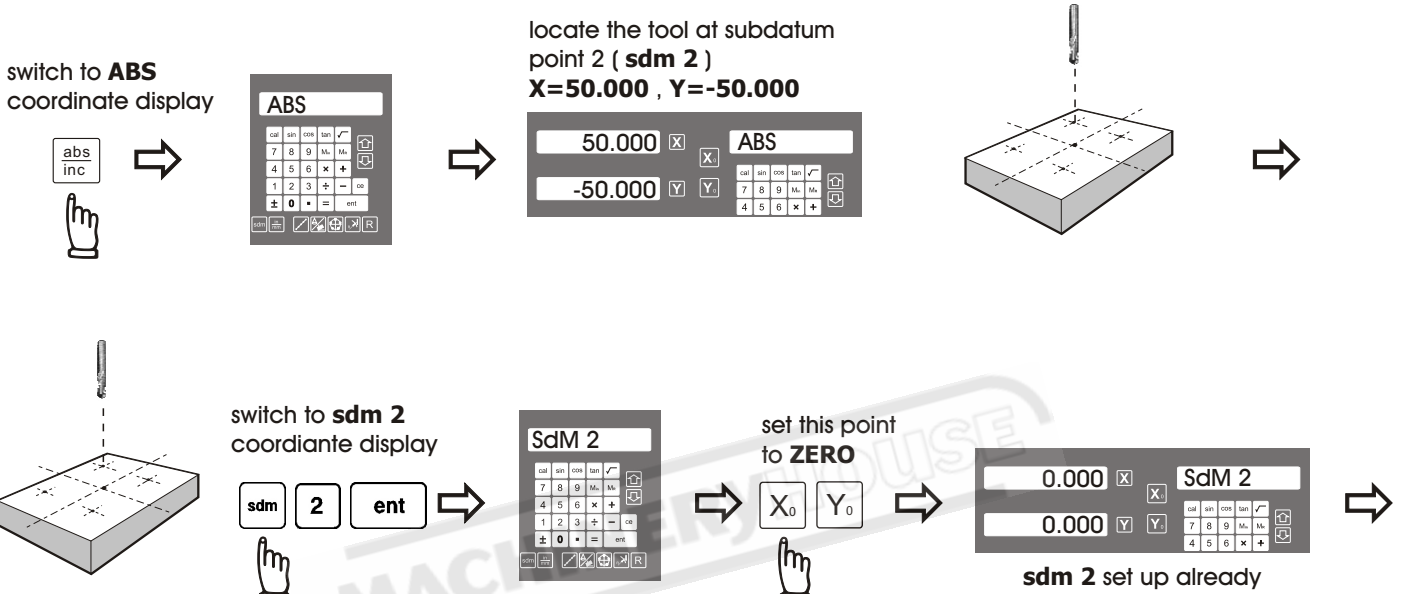

### Step 4: setup the subdatum point 3 ( sdm 3 )

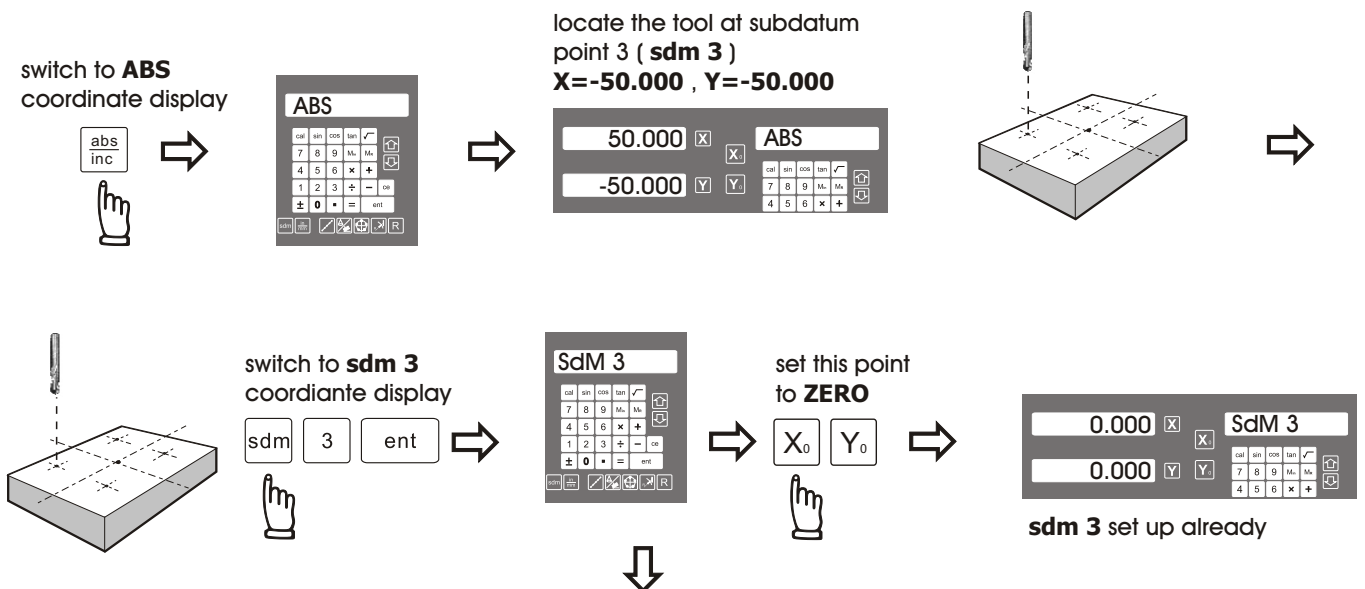

## 199 Subdatum Function

### Step 5: setup the subdatum point 2 ( sdm 4 )

switch to **ABS**  
coordinate display



locate the tool at subdatum  
point 2 ( sdm 4 )  
**X=-50.000 , Y=35.000**

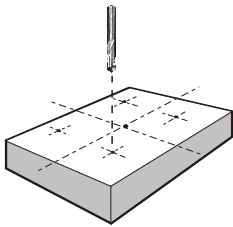
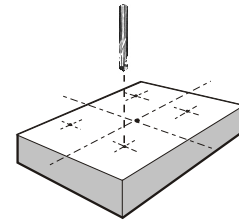
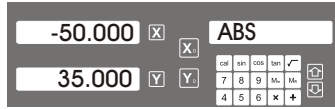

switch to **sdm 4**  
coordinate display

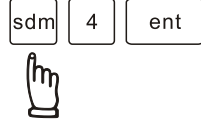

set this point  
to **ZERO**

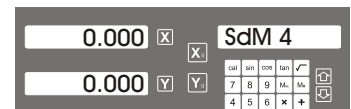
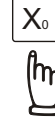

**sdm 4 set up already**

### All the four subdatum points have already been set up

operator can press  or  to directly switch to the required subdatum ( sdm ) coordinate



#### Example :

switch to **ABS**  
coordinate display

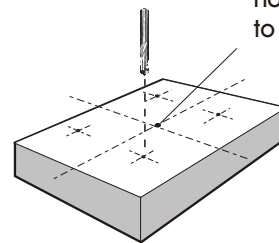
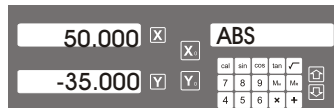

The DRO's XY displays is  
now switched to referred  
to **ABS** zeros

switch to next ( **UP** )  
**sdm** coordinate display

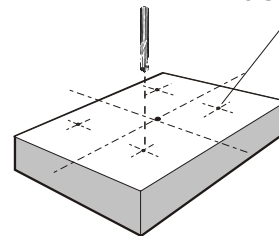
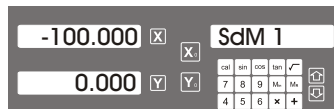

The DRO's XY displays is  
now switched to referred  
to **sdm 1** zeros

## 199 Subdatum Function

switch to next ( **UP** )  
sdm coordinate display

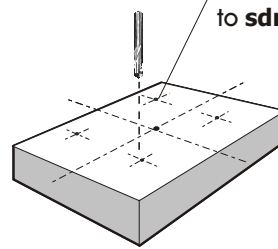
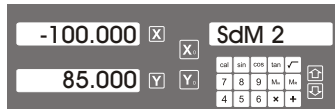

The DRO's XY displays is now switched to referred to **sdm 2** zeros

switch to next ( **DOWN** )  
sdm coordinate display

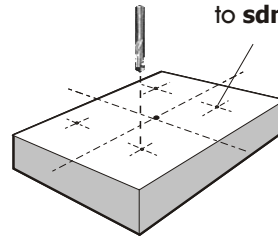
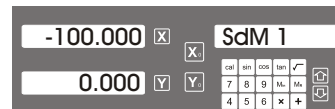

The DRO's XY displays is now switched to referred to **sdm 1** zeros

In case of many subdatum ( sdm ) points needed to be set up, operator will find that the method of direct keyin the sdm zero position coordinate ( coordinate relative to ABS zero ) is a much more quicker, more efficient and less mistaken method.

### Method 2 : direct keyin the sdm zero position coordinate ( coordinate relative to ABS zero )

The subdatum ZERO positions can be keyed into the DRO directly, it is a much more easier, quicker and less mistaken method compared to the method 1 .

**Step 1:** setup the work piece datum in **ABS** coordinate

switch to **ABS**  
coordinate display

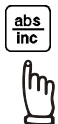

locate the tool at the work  
piece datum point

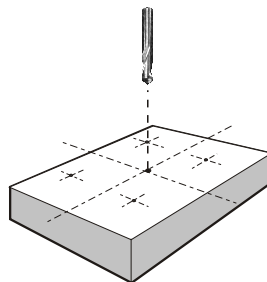

set this point  
to **ZERO**

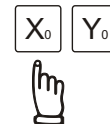

## 199 Subdatum Function

### Step 2: setup the subdatum point 1 ( sdm 1 )

switch to **sdm 1**  
cooriante display

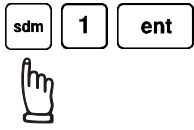

X 5 0 sdm



Y 3 5 sdm

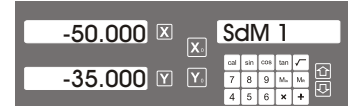

#### Notice :

when the coordinate is entered into the DRO, the displayed coordinate in the axis display shows a **negative sign** of your entered coordinate

**It is correct** because your tool is now located at the ABS zero coordinate, if you look from the sdm coordinate, it is right at the negative value of the sdm zero position coordinate

### Step 3: setup the subdatum point 2 ( sdm 2 )

switch to **sdm 2**  
cooriante display

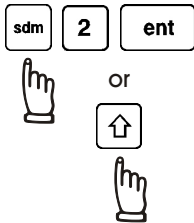

Keyin the **sdm 2** coordinate

X 5 0 sdm



Y ± 5 0 sdm



### Step 4: setup the subdatum point 3 ( sdm 3 )

switch to **sdm 3**  
cooriante display

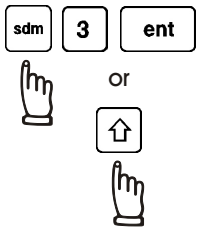

Keyin the **sdm 3** coordinate

X ± 5 0 sdm



Y ± 5 0 sdm

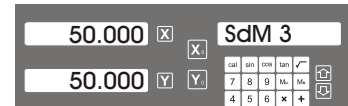

### Step 5: setup the subdatum point 4 ( sdm 4 )

switch to **sdm 4**  
cooriante display

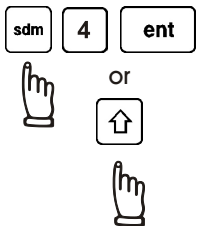

Keyin the **sdm 4** coordinate

X ± 5 0 sdm



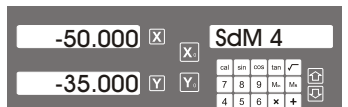

Y 3 5 sdm



# 199 Subdatum Function

All the four subdatum points have already been set up

operator can press  or  to directly switch to the required subdatum ( **sdm** ) coordinate

## Example :

switch to **ABS**  
coordinate display

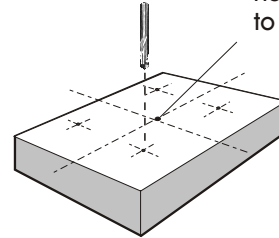
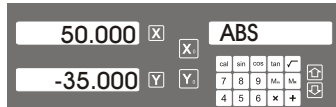

The DRO's XY displays is now switched to referred to **ABS** zeros

switch to next ( **UP** )  
**sdm** coordinate display

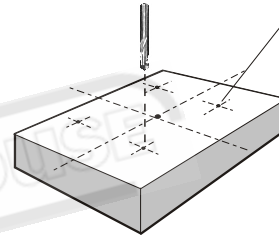
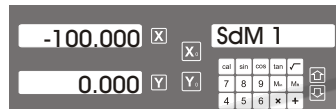

The DRO's XY displays is now switched to referred to **sdm 1** zeros

switch to next ( **UP** )  
**sdm** coordinate display

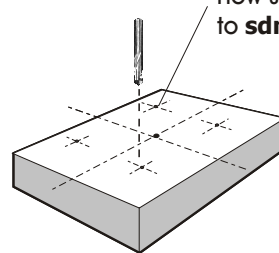
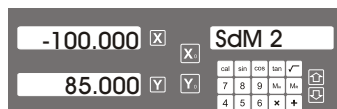

The DRO's XY displays is now switched to referred to **sdm 2** zeros

switch to next ( **DOWN** )  
**sdm** coordinate display

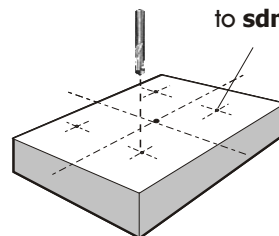
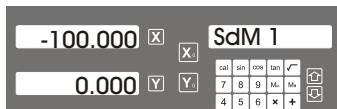

The DRO's XY displays is now switched to referred to **sdm 1** zeros

---

# REF datum memory

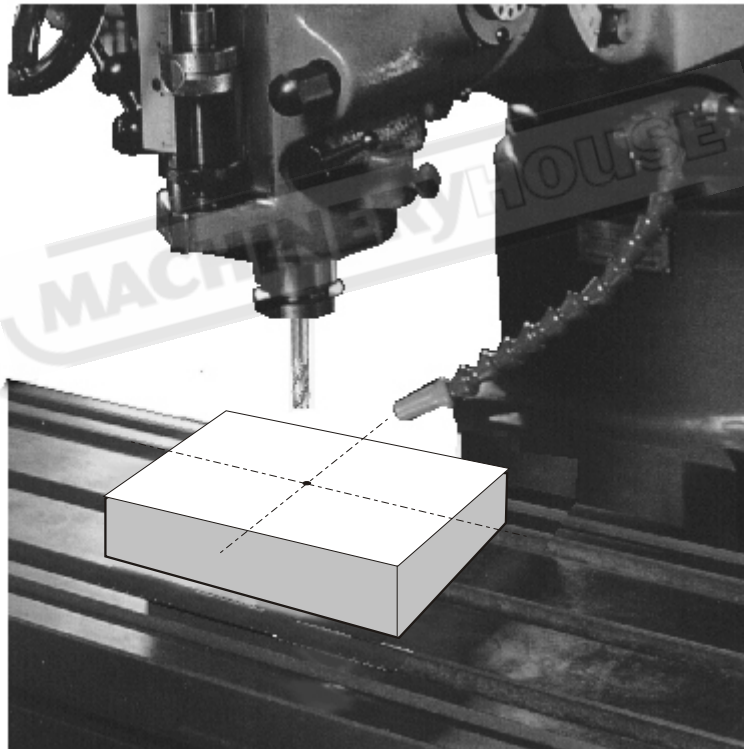



---

## REF datum memory function - working principal

---

**Function :** In daily machining process, it is very common that the machining cannot be completed within one work shift, the DRO has to be switched off after work hours, or power failure happens during the machining process which inevitably lead to the lost of work piece datum ( work piece's ABS zero position ), the re-establishment of work piece datum using edge finder or other method is inevitably induce higher machining inaccuracy because it is not possible to re-establish the work piece datum at the exact position as per the previous datum.

To allow the recovery of work piece datum very accurately, and no need to re-establish the work piece datum using edge finder or the other methods, every glass grating transducer has a **REF** mark which is a fixed position in the glass grating transducer. We can simply store the relative distance between the work piece datum and this **REF** mark into the DRO's memory, after recovered from a power failure, we can re-install the stored relative distance from the **REF** mark to re-establish the work piece datum.

Followings are the detailed work principal of the **REF** datum memory :

- there is a permanent and fixed mark ( position ) in the center of every glass grating scale, normally it is called **REF** mark or **REF** point.
- since this **REF** point position is permanent and fixed, it will never change or disappear even when the DRO is switched off. Therefore, we can simply store the relative distance between this **REF** mark and the work piece datum ( ABS zero position ) in the DRO's memory. Then in case of power failure happen, after recovery from the power failure, we can use the **REF** datum memory function to re-install the store relative distance from the **REF** mark to re-establish the work piece datum ( ABS zero position ).

**Example :** to store the X axis work datum

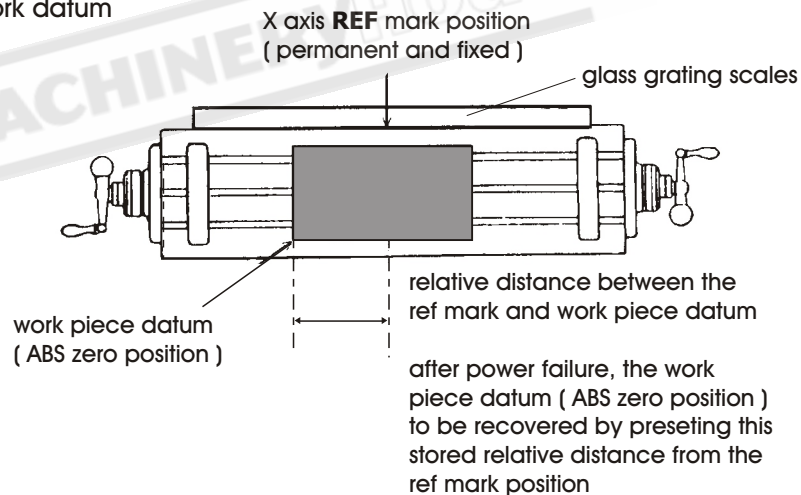

**Operation :** ES-8A provides one of the best and most easy to use REF datum memory function in this industry.

There is no need to store the relative distance between the REF mark and your work piece datum, whenever you make any clear zero, position preset or center find operating in ABS coordinate, this relative distance is automatically stored into the battery backup or ferrite core permanent memory, it will last so long as you don't change or update it, after you lost the work datum zero, you simply use the recall 0 function to restore your work piece datum.

However, you need to carry out the REF FIND function at least one time before you make any important machining. This is to let the DRO know where the ref mark is located. It is a very good practise to perform REF FIND function at least one time on every "power up" of the DRO ( if possible ), If you plan to machine an important or serious job, please remember to perform REF FIND at least one time before you start any important machining. Only perform REF FIND one time is enough for every switch on of the DRO.

## REF datum memory function - FIND REF

**Function :** In all basic functions of this DRO, such as dimension preset, zeroing, center find and etc., the DRO will automatically store the relative distance between the **REF** mark and the work piece datum ( ABS Zero position ), however, it is the most vital and basic that the DRO must know where the **REF** mark is located.

The REF FIND function is to let the DRO know where is the **REF** mark located. **If the operator do not perform this function at least one time after the power up of the DRO, then the DRO don't know where ther REF mark is located, and subsequently all the recall 0 function is totally useless and incorrect !**

Therefore, **it is a very good practise to perform the REF FIND function at least one time on every power up of the DRO, or before any important machining**, if you have perform the REF FIND once after the power up of the DRO, then you have no need to worry of losing your work piece datum no matter what power failure accident happen. You are for sure the work datum will never losted.

**Step 1 :** enter into the ref function, select the **FIND REF** ( find **REF** mark )

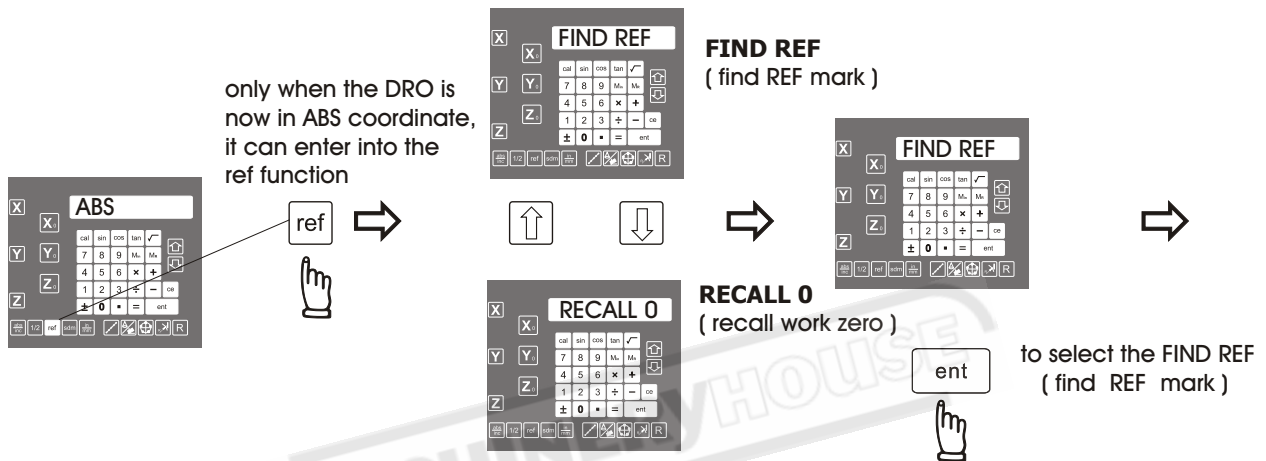

**Step 2 :** select the axis of which the REF mark needed to be found

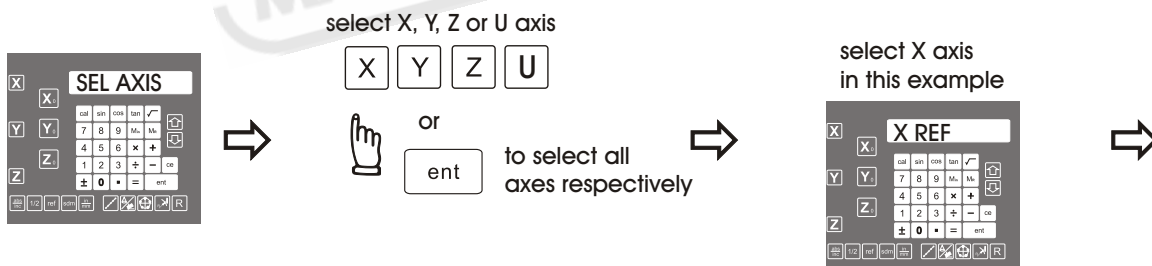

**Step 3 :** move the machine across the center of the glass grating scale until the X axis digit display starts run. ( **please notice that the machine move must toward the positive direction** )

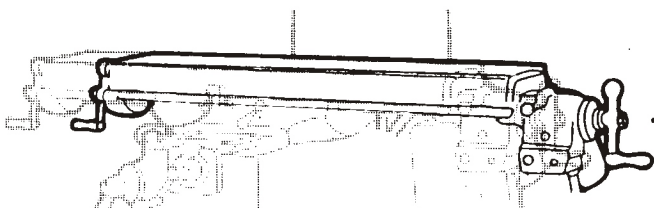
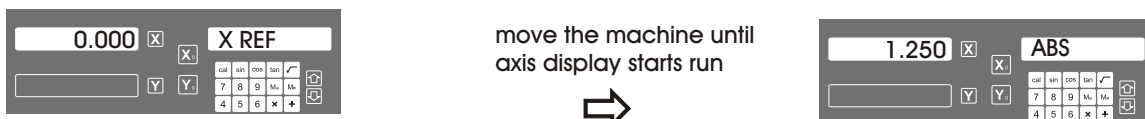

move the machine across the centre of the glass grating scale. ( must moving towards **positive direction**, otherwise no start count is possible )

*To improve the accuracy of the REF FIND, and avoid any backlash errors caused by old or inaccuracy machines, the REF FIND is designed to work on positive direction only*

## REF datum memory function - RECALL 0

**Function :** after the lost of work piece datum due to power failure or switch off of the counter, the work piece datum can be recovered by **RECALL 0** function.

**Please notice that if the operator do not perform the REF FIND at least one time before the establishment of the work piece datum ( ABS zero position ), the RECALL 0 will give an error work datum position.**

**Step 1 :** enter into the ref function, select the **RECALL 0** ( recall work piece ZERO )

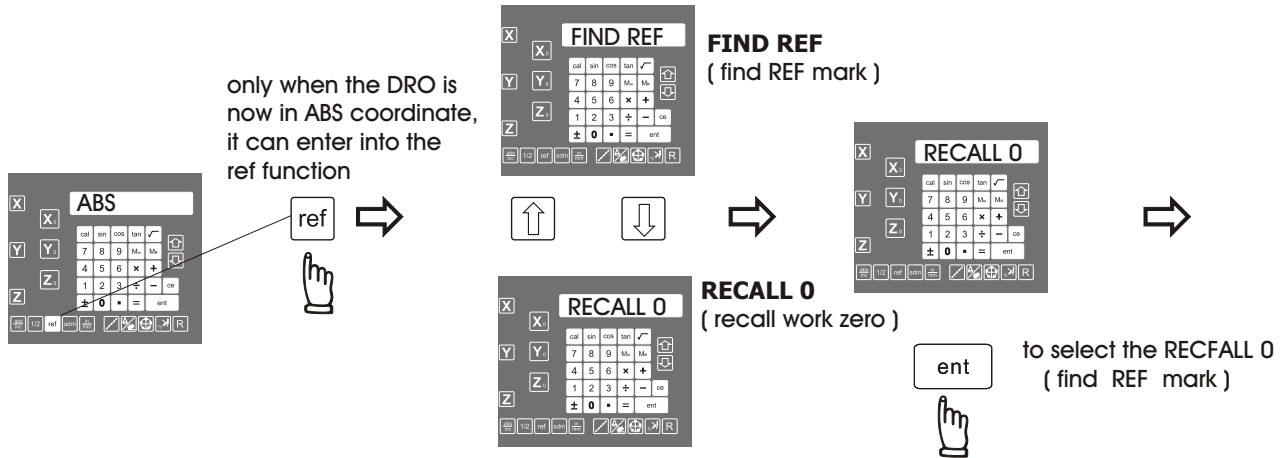

**Step 2 :** select the axis of which the work piece datum needed to be recalled

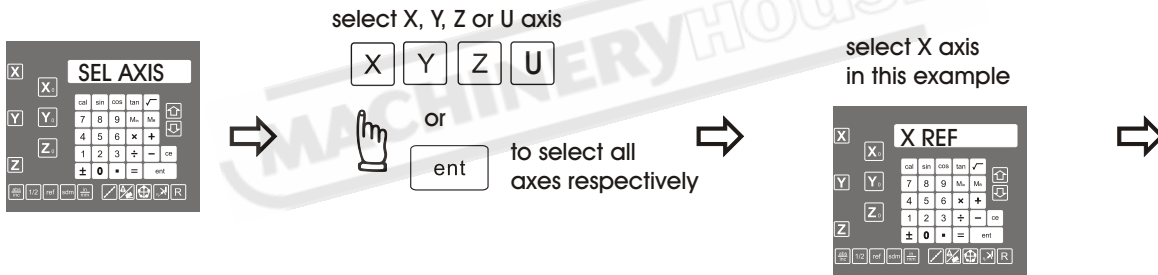

**Step 3 :** move the machine across the center of the glass grating scale until the X axis digit display starts run. ( **please notice that the machine move must toward the positive direction** )

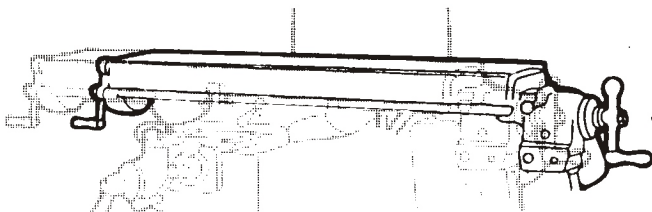
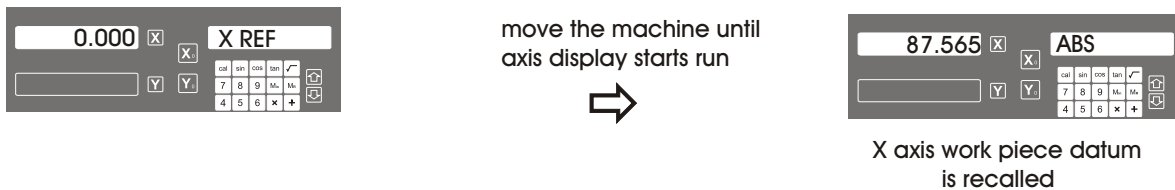

move the machine across the centre of the glass grating scale. ( must move towards **positive direction**, otherwise no start count is possible )

*To improve the accuracy of the RECALL 0, and avoid any backlash errors caused by old or inaccuracy machines, the RECALL 0 is designed to work on positive direction only*

---

## **LHOLE** - tool positioning for the Line Holes

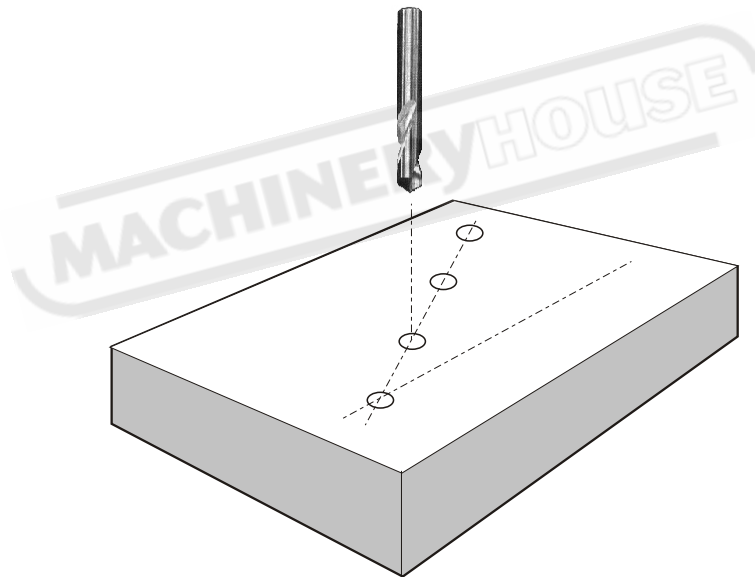



## LHOLE - tool positioning for Line Holes

**Function:** ES-8A provides the LHOLE function for tool positioning for the holes drilling along a line, operator simply enter the machining parameters as per the step by step guide that shown on the DRO's message display, then the DRO will calculate all the holes position coordinate, and temporarily preset those holes' position to zero ( 0.000, 0.000 ). Operator simply move the machine until the X,Y axes displays = 0.000, 0.000, then the Line Holes' position are reached.

Machining parameters :

- Line angle ( **LIN ANG** )
- Line distance ( **LIN DIST** )
- No. of holes ( **NO. HOLE** )

after the above machining parameters are entered into the DRO, the LHOLE function will temporarily preset all Line Holes' position = ( 0.000, 0.000 )

operator can press  or  keys to select the Line Holes, and move the machine to display = ( 0.000, 0.000 ), then the Line Holes' position is reached.

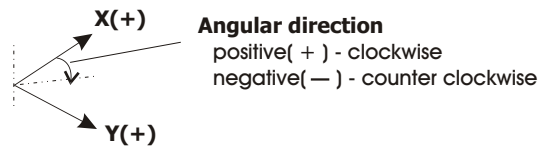
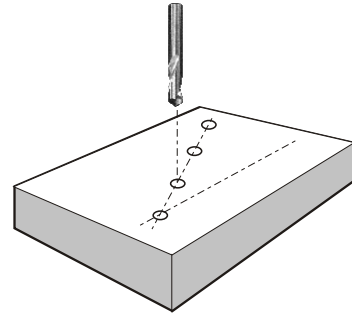

### Example

Line angle ( **LIN ANG** ) ..... -30 degree ( counter clockwise )  
 Line distance ( **LIN DIST** ) ..... 80.000 mm  
 No. of holes ( **NO.HOLE** ) ..... 4

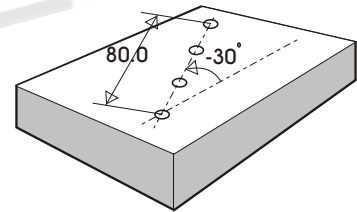

**Step 1 :** Posit the tool at the first Line Hole position.

The current tool position is used to be the first Line Hole position in the LHOLE function. Therefore, before entering into the LHOLE function, we must first posit the tool at the first Line Hole position.

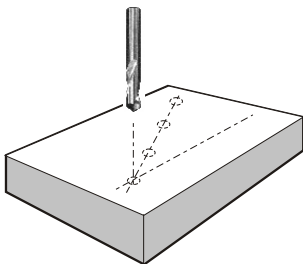

locate the tool at the **first Line Hole** position

enter the **LHOLE** function

enter the Line angle ( **LIN ANG** )

# LHOLE - tool positioning for Line Holes

## Step 2 : enter Line angle ( LIN ANG )

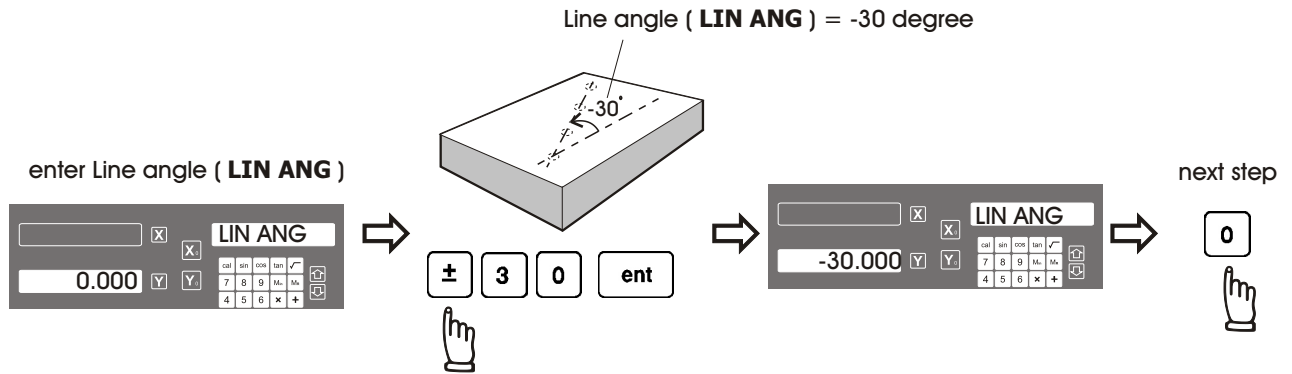

## Step 3 : enter Line distance ( LIN DIST )

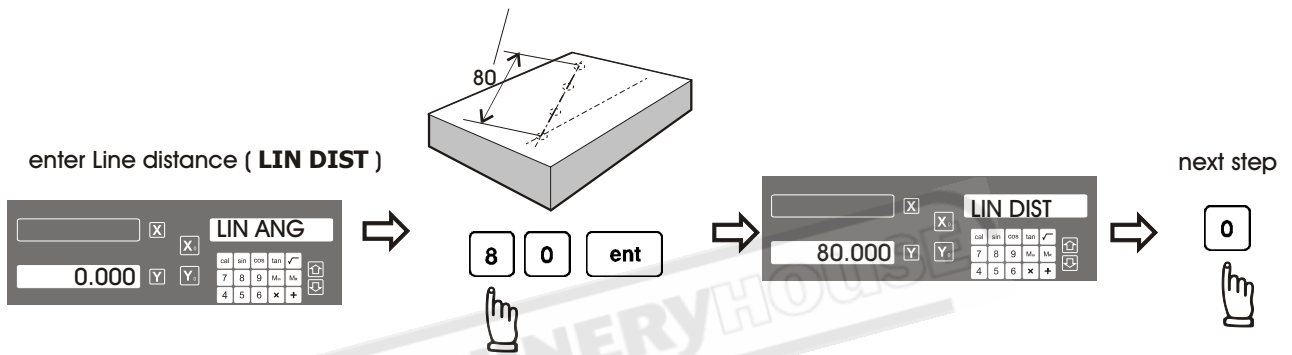

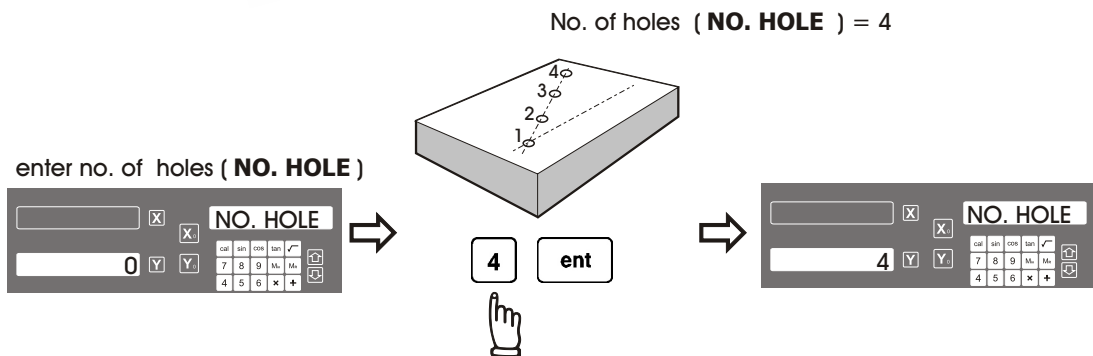

## Step 4 : enter no. of holes ( NO. HOLE )



all LHOLE machining parameters already entered into the DRO



to enter into the LHOLE machining mode

operator can press  or  to select the Line Hole's number, then move the machine to display = 0.000, then the Line Hole position are reached.



# LHOLE - tool positioning for Line Holes

next Line Hole



move the machine to axes display  
= ( 0.000, 0.000 )

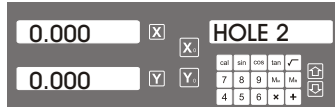

HOLE 2 = Line Hole no. 2

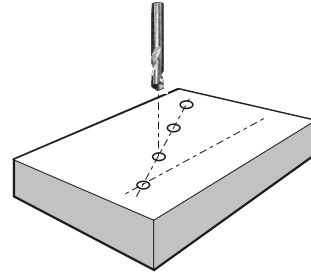

previous Line Hole



move the machine to axes display  
= ( 0.000, 0.000 )



HOLE 1 = Line Hole no. 1

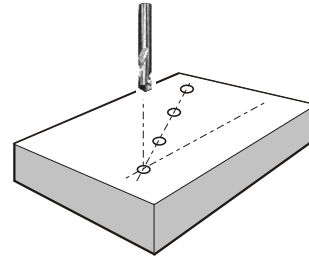

Anytime the operator want to check or verify if the DRO's LHOLE calculation correct or not, or want to temporarily exit the LHOLE function cycle ( swap back to normal XYZ display ), procedure are as follows :

presently in **LHOLE** cycle



temporarily swap to normal  
XYZ coordinate display



temporarily return to  
XYZ coordinate display

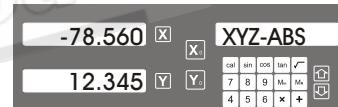

swap back to **LHOLE** function cycle to continue the Line Holes machining operation

presently in the temporarily  
XYZ coordinate display

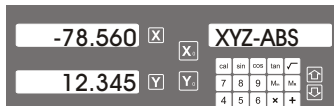

swap back to **LHOLE**  
function cycle



After the Line Holes machining operation completed, press  to exit from the LHOLE function cycle.



presently in **LHOLE** function cycle



exit LHOLE function, return to  
normal display

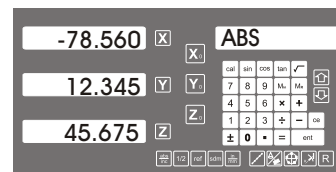

## INCL - Inclined angle tool positioning

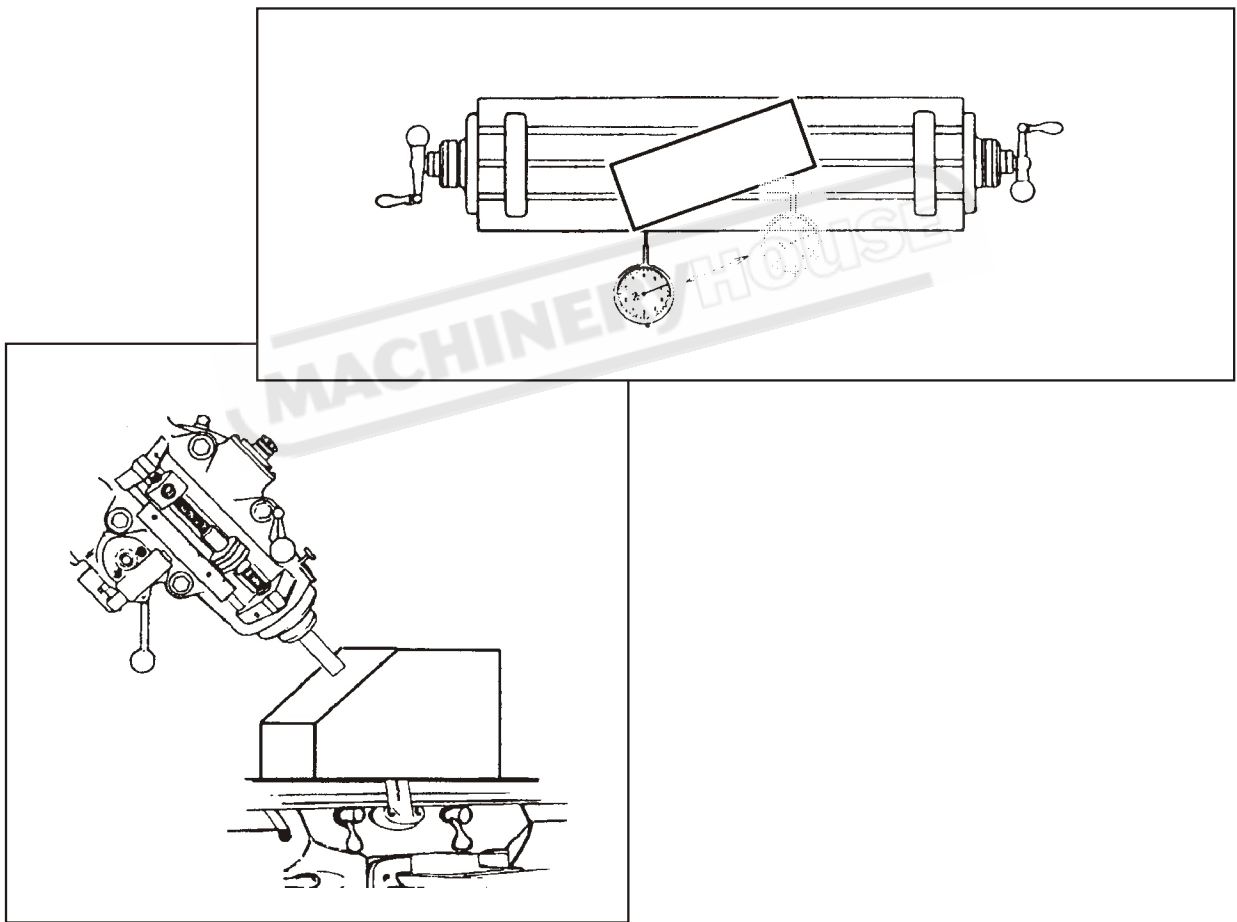



## INCL - Inclined angle tool positioning

**Function :** In daily machining, it is quite common to machine an inclined surface, or datum the work piece at an inclined angle to X or Y axis.

If the work piece is small or the accuracy requirement is low, operator can simply put the work directly onto an inclined table or rotary table to machine the inclined work surface.

However, when the work piece is too big to be installed onto an inclined table or the accuracy requirement is high. The only solution is to calculate the machining positions using mathematical method. It is very time consuming

ES-8A provides an very easy to use INCL function to help the operator to posit the tool along an inclined angle.

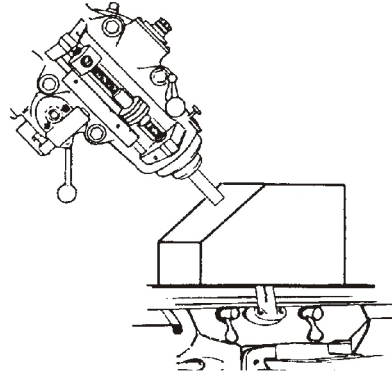

### application example of the INCL function :

A) XY plane - to accurately datum the work piece at an inclined angle

B) XZ/YZ plane - to machine an inclined surface ( only when 3 axis DRO is used )

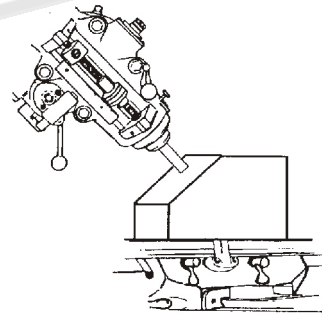
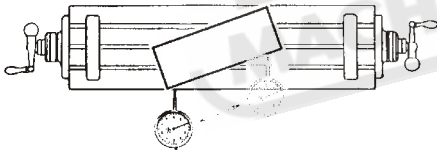

**For lathe application, since the lathe have very different machine structure compared to milling machines, please refer to the chapter of "Supplement to Lathe application"**

### Example :

to accurately datum the work piece at 20 degree inclined from X axis

in this example, since the incline is counter clockwise, therefore, the angle is **-20 degree**

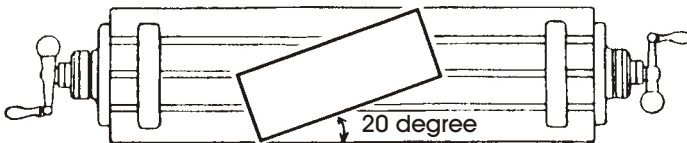

### Angle convention

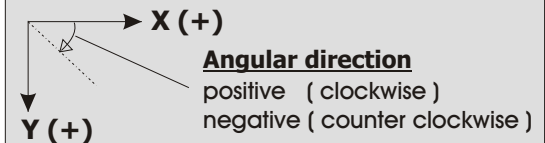

# INCL - Inclined angle tool positioning

## Operation procedure

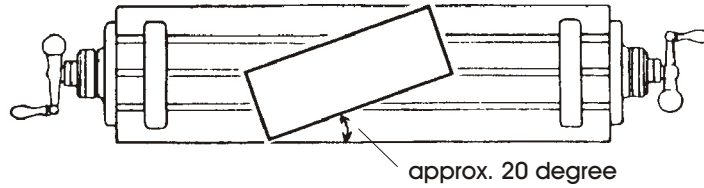

install the work piece onto an rotary table at approximately 20 degree as shown in the above diagram.

### Step 1 : select the XY plane as the work plane ( **INCL-XY** )

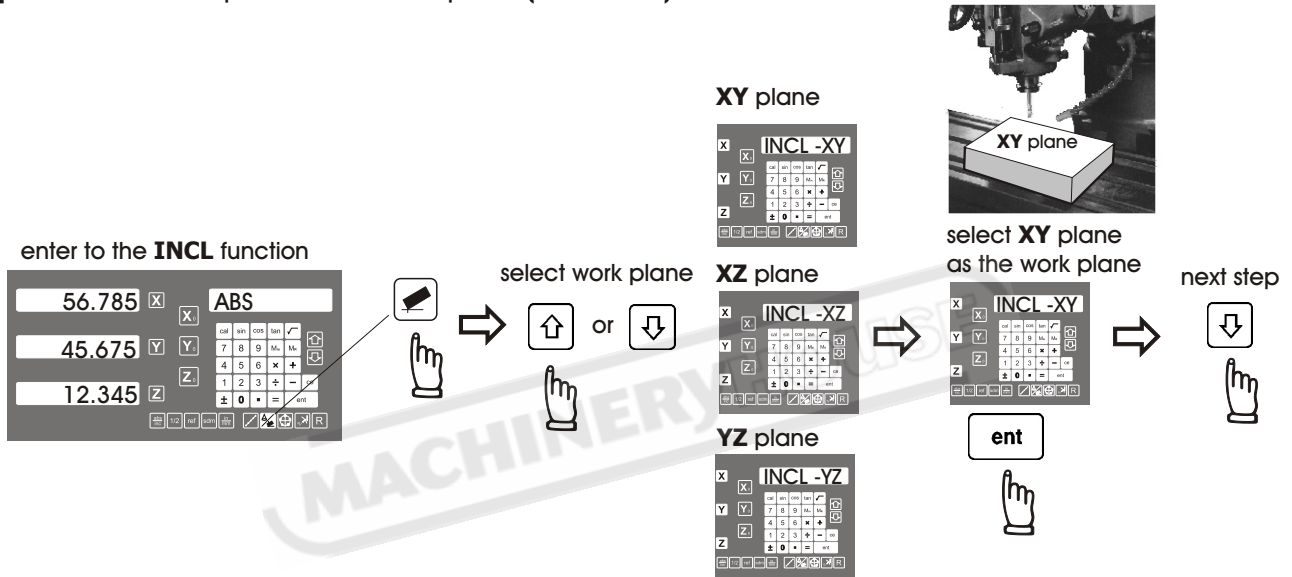

### Step 2 : enter the inclined angle ( **INCL ANG** )

Inclined angle ( **INCL ANG** ) = -20 degree ( counter clockwise )

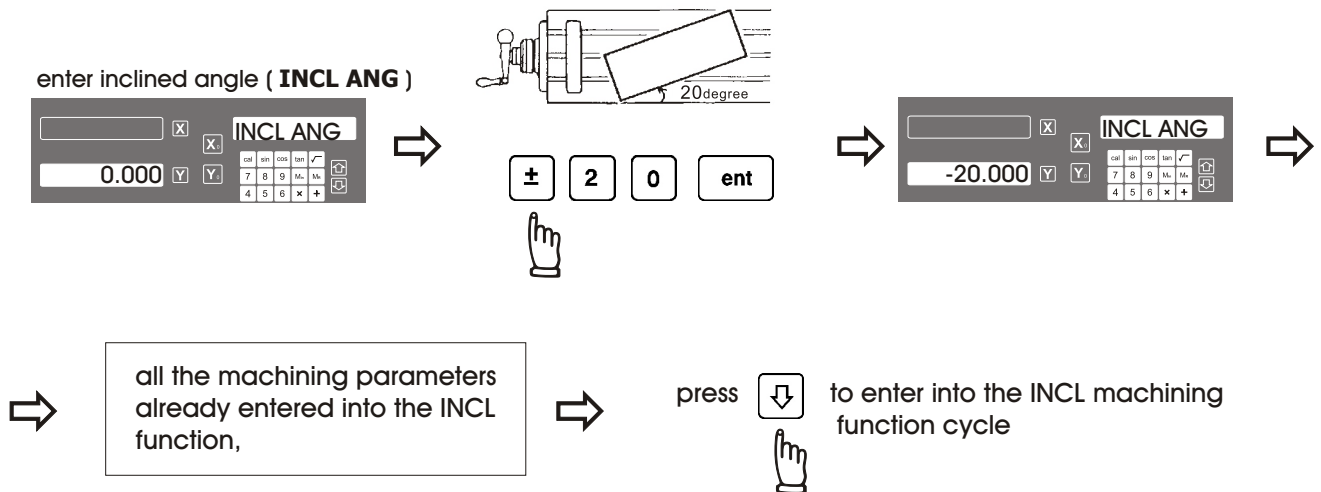

## INCL - Inclined angle tool positioning



The DRO is now entered into the INCL machining function cycle

the datuming of the work piece at an inclined angle of 20 degrees is an iterative process, operations are as follows :

**A ) ZERO the dial indicator at one end of the work piece**

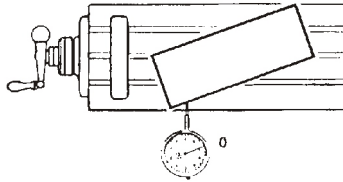

zero the X axis  
to redatum the  
X axis

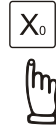

**XY plane INCL machining mode display**



Y display is shifted left to remind the operator that the axis display zero position is preset to  $= X * \tan(\text{ANG})$  operator simply move the machine to  $Y = 0.000$ , then the tool is accurately located at the inclined axis.

iterate between A) & B) until the alignment error is within the acceptable range

**B )** after move the machine to Y axis display = 0.000, then Y axis position is accurately posited at the 20 degree, operator can fine tune the work piece's incline angle until the dial indicator pointing at ZERO

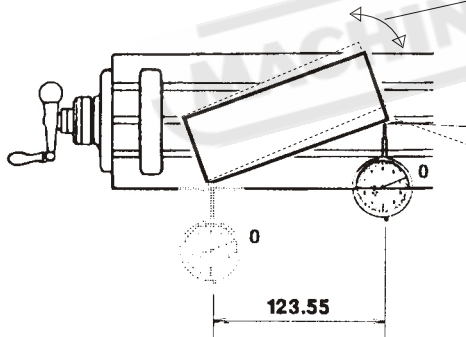

Since during the work piece's inclined angle alignment, angular adjustment of any one end of the work piece will inevitably affect the position of the opposite end. Therefore, the above angular alignment fine tuning procedure A) & B) have to be carried out iteratively until operator satisfy with the angular error of the alignment achieved.

## INCL - Inclined angle tool positioning

Anytime the operator want to check or verify if the DRO's INCL calculation correct or not, or want to temporarily exit the INCL machining mode display ( swap back to normal XYZ display ), procedure are as follows :

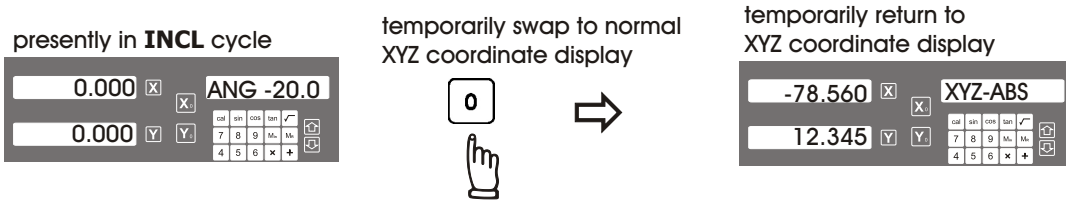

swap back to **INCL** machining mode display continue the INCL machining operation

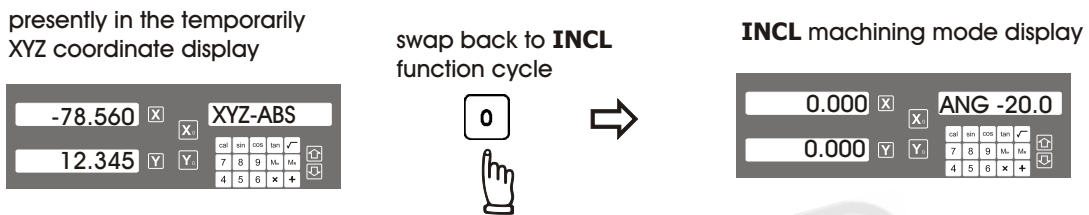

After the **INCL** machining operation completed, press  to exit from the INCL function cycle.

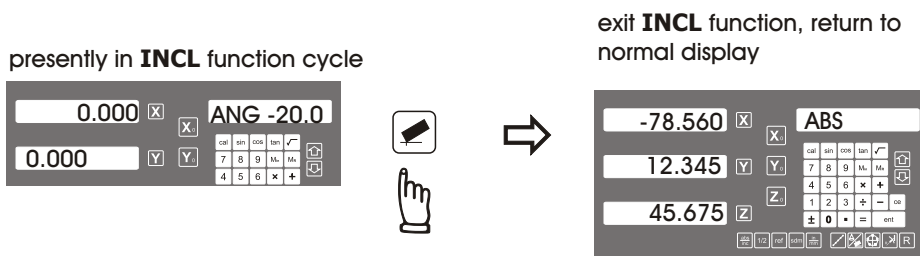

---

**PCD - tool positioning for Pitch Circle Diameter**

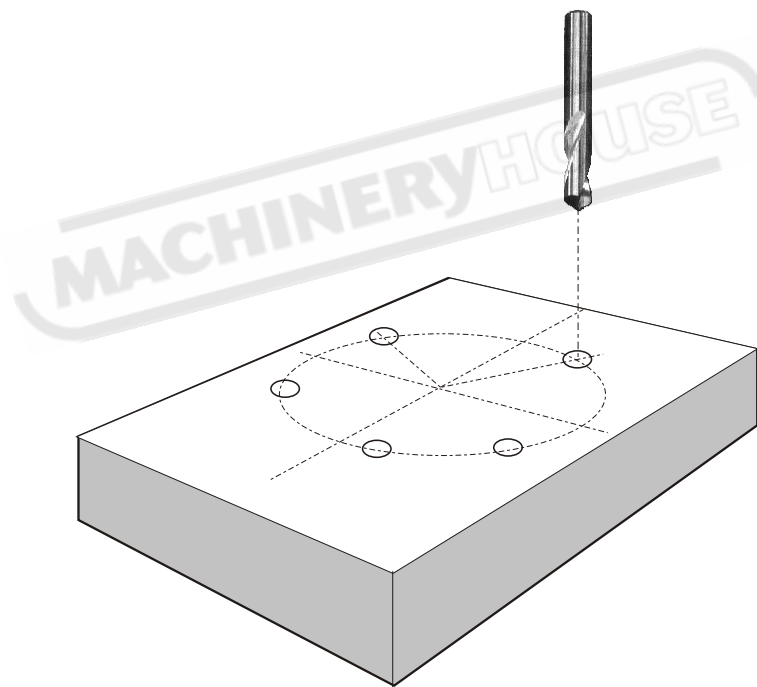

## PCD - tool positioning for Pitch Circle Diameter



**Function :** ES-8A provides the PCD function for tool positioning for the drilling of the pitch holes along a Circle, operator simply enter the machining parameters as per the step by step guide that shown on the DRO's message display, then the DRO will calculate all the pitch holes position coordinate, and temporarily preset those holes' position to zero ( 0.000, 0.000 ). Operator simply move the machine until the X,Y axes display = 0.000, 0.000, then the Pitch Holes' position are reached.

Machining parameters :

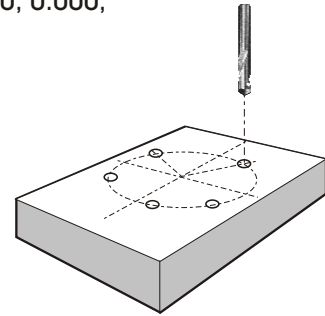
- Centre ( **CENTRE** )
- Diameter ( **DIA** )
- No. of holes ( **NO. HOLE** )
- Start angle ( **ST. ANG** )
- End angle ( **End ANG** )



after the above machining parameters are entered into the DRO, the PCD function will temporarily preset all Pitch Holes' position = ( 0.000, 0.000 )

operator can press  or  keys to select the Pitch Holes, and move the machine to display = ( 0.000, 0.000 ), then the Pitch Holes' position along a circle is reached.

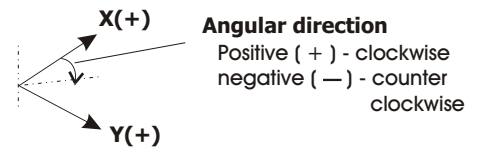

### Example

Machining parameters :

- Centre ( **CENTRE** ) ..... X=0.000, Y=0.000
- Diameter ( **DIA** ) ..... 80.000 mm
- No. of holes ( **NO. HOLE** ) ..... 5 holes
- Start angle ( **ST. ANG** ) ..... 30 degree ( clockwise )
- End angle ( **End ANG** ) ..... 300 degree ( clockwise )

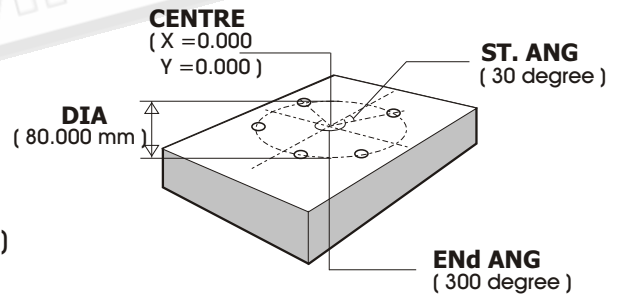

**Step 1 :** Setup the work piece datum ( work piece zero ), press  to enter into the **PCD** function

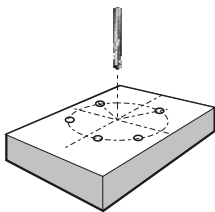

set up the work piece datum

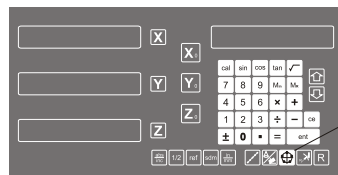

enter into **PCD** function



enter the **CENTRE** coordinate

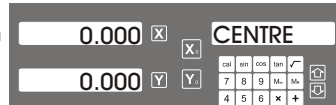

# PCD - tool positioning for Pitch Circle Diameter

## Step 2 : Enter the Centre coordinate ( CENTRE )

centre coordinate ( CENTRE ) : X=0.000, Y=0.000

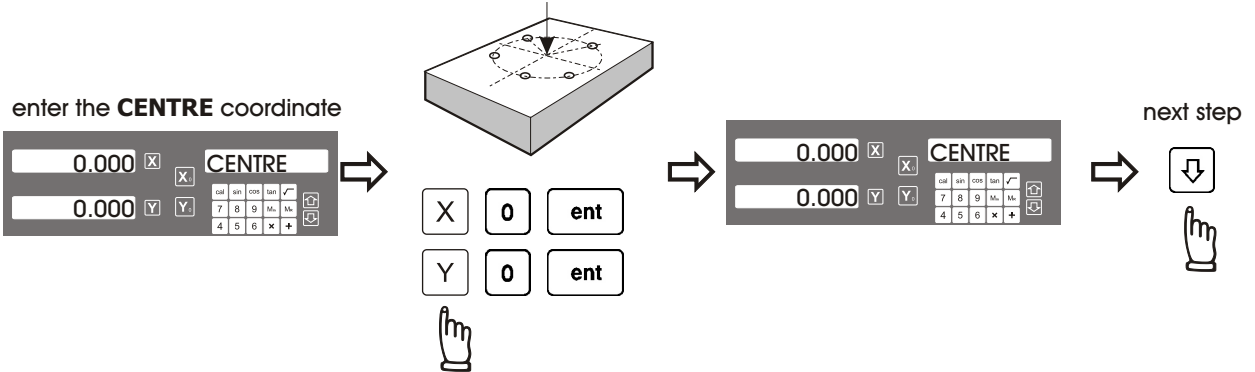

## Step 3 : Enter Diameter ( DIA )

Diameter ( DIA ) = 80.000mm

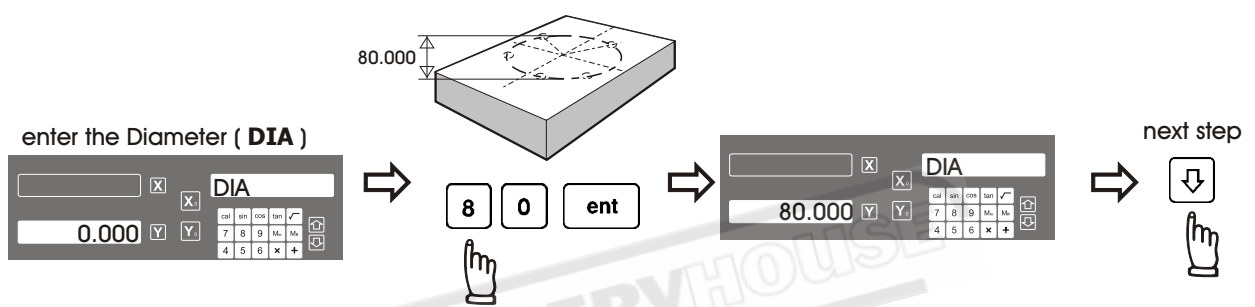

## Step 4 : Enter No. of Holes ( NO. HOLE )

No. of Holes ( NO. HOLE ) = 5

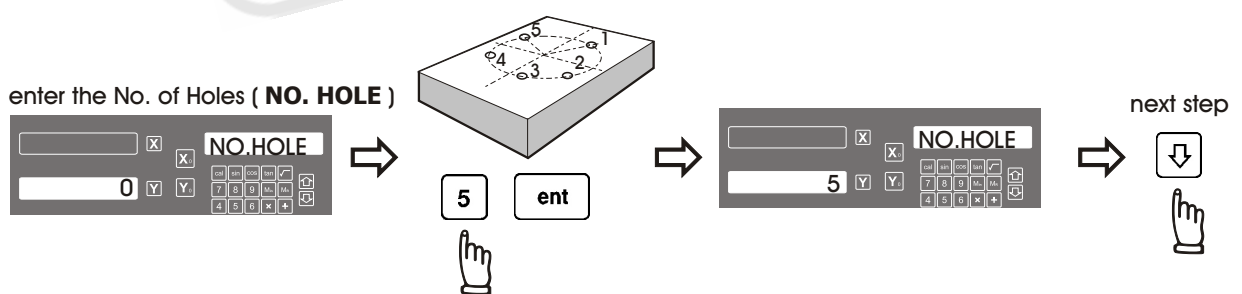

## Step 5 : Enter the Start angle ( ST. ANG )

Start angle ( ST. ANG ) = 30 degree

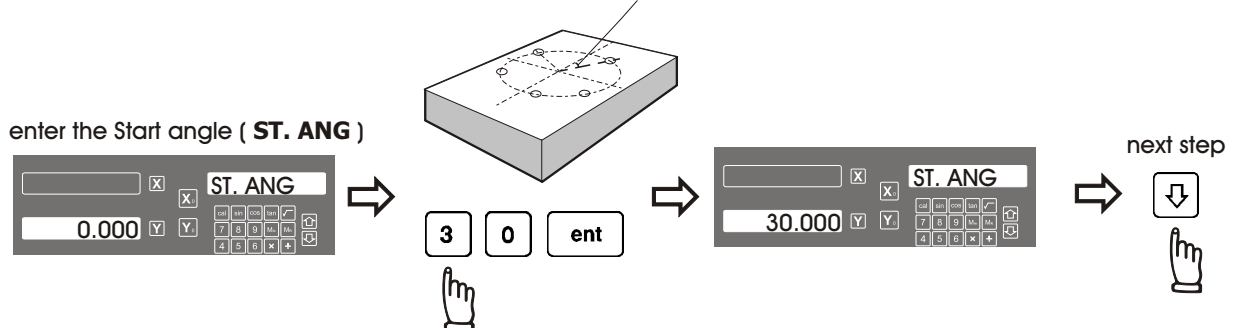

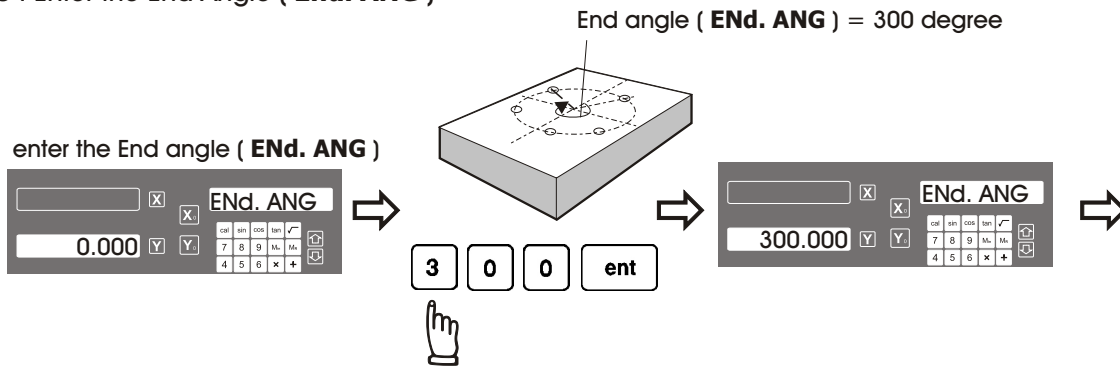

# PCD - tool positioning for Pitch Circle Diameter

## Step 6 : Enter the End Angle ( **End. ANG** )



all PCD machining parameters already entered into the DRO  to enter into the PCD machining mode

operator can press  or  to select the Pitch Hole's number, and move the machine to display = 0.000, then the Pitch Hole position is reached.

next Pitch Hole



move the machine to axes display = ( 0.000, 0.000 )



HOLE 2 = Pitch Hole no. 2

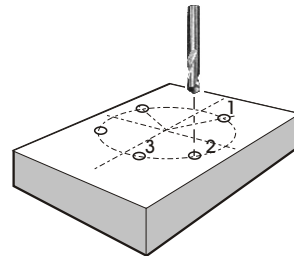

previous Pitch Hole



move the machine to axes display = ( 0.000, 0.000 )



HOLE 1 = Pitch Hole no. 1

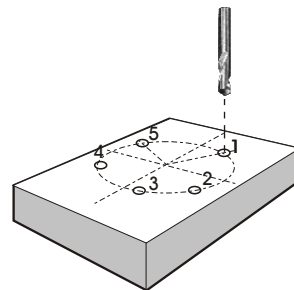



## PCD - tool positioning for Pitch Circle Diameter

Anytime the operator want to check or verify if the DRO's PCD calculation correct or not, or want to temporarily exit the PCD function cycle ( swap back to normal XYZ display ), procedure are as follows :

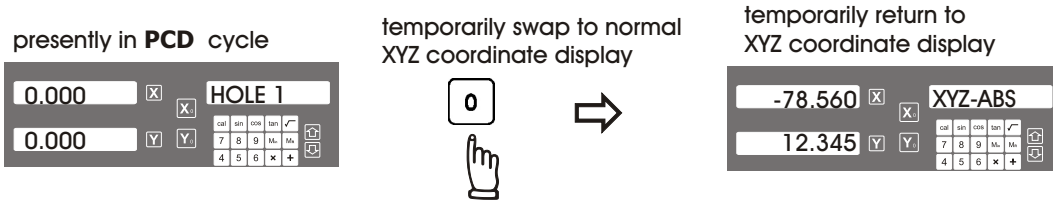

swap back to **PCD** function cycle to continue the PCD machining operation

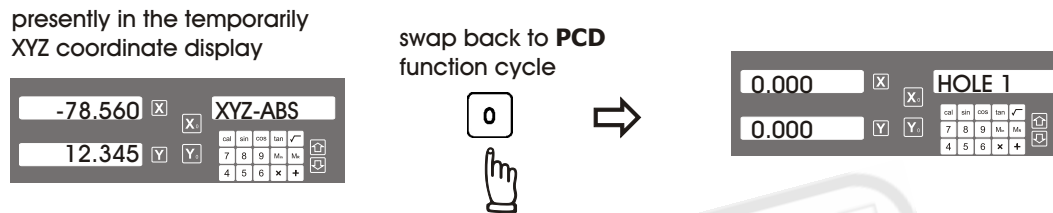

After all Pitch Holes machining operation completed, press  to exit from the PCD function cycle.

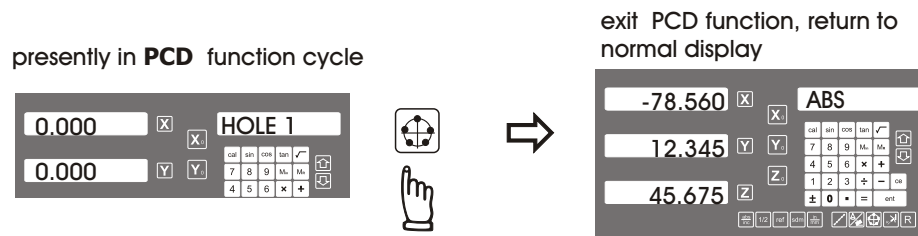

# tool positioning for ARC machining

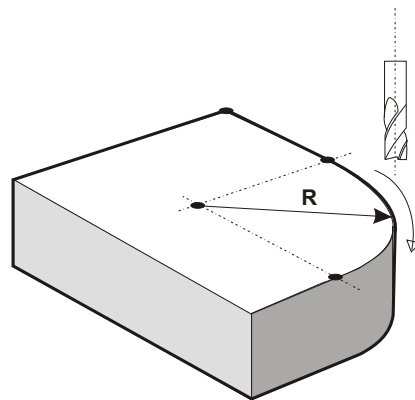
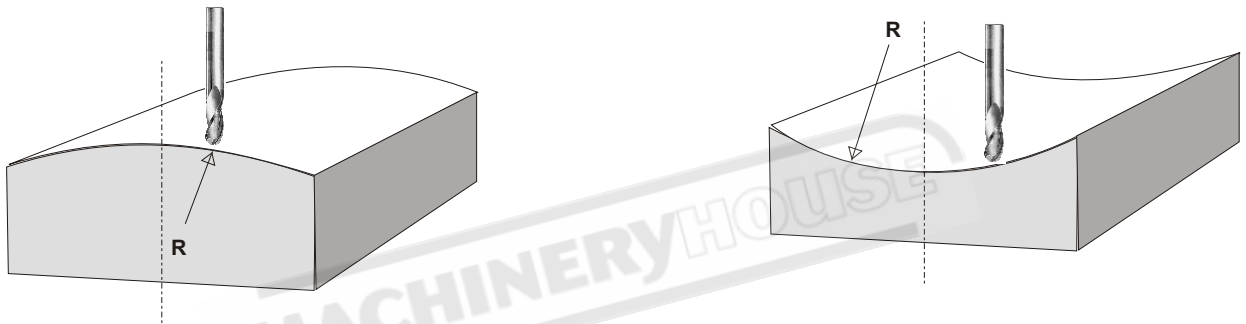

## tool positioning for ARC machining

**Function :** During daily machining, it is quite frequently to machine a round corner or arc surface, especially in mould making.

Of course, if the arc surface is complicated or quite a number of round corners have to be machined, or very precise arc or round corners needed to be machined, then CNC milling machine should be used.

But there is still a lot of the cases that only very simple arc surface or only one or two round corners needed to be machined. The precision of those arc or round corners machining are not demanding at all (especially in mould making). If we do not have CNC machine in house, it is then more cost effective and time saving to carry out those relatively simple arc or round corners machining on your manual milling machine in house rather than sub-contract those CNC machining to an external sub-contractor.

In the past, many mould makers made their tool positioning calculation for ARC machining with a scientific calculator. But the process is time consuming and easily make mistake.

ES-8A features with a very easy to use tool positioning function for ARC machining which enable the operator to make simple ARC machining in shortest possible time. But before you make your decision to use the ARC function or to have your work piece to be machined in a CNC machine, please bear in mind that ARC function is only cost effective and time saving under following conditions.

### 1) One Off Job

### 2) Only simple ARC surface or round corners to be machined.

## ARC function groups

The ARC function of the ES-8A consists of only one program, this program have following two functions

### R function

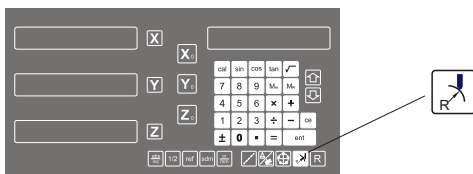

R function provides maximum flexibility in ARC machining, the ARC sector to be machined is defined by the coordinates of :

- 1) ARC centre ;
- 2) ARC Radius ;
- 3) ARC start point
- 4) ARC end point

#### Advantage :

- Very flexible, R function can machine virtually all kind of ARC, even the intersected ARCs

#### Limitation :

- Relatively a bit complicated to operate, operator need to calculate and enter the coordinate of ARC centre, start point and end point into the DRO.

### Simplified R function

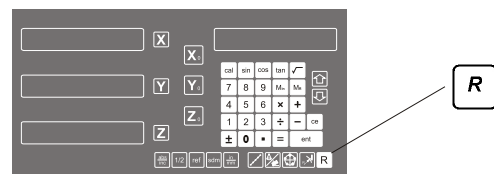

Since the ARC function of the ES-8A is aimed to machine only the very simple ARC or round corners, to make the operation really very simple to the operator, then DRO preset eight types of most frequently used ARC machining process, it make the operator virtually no need to make any calculation in the parameters entry.

#### Advantage :

- Very easy to use, operator just posit the tool at the ARC's start point, select the preset R type and ARC radius, then he can start machining the ARC right away.

#### Limitation :

- Restricted to only eight types of presetted ARC, cannot machine more complicated ARC such as intersected ARC and etc..

# R function

## Understanding the Coordinate System :

For those operator whom don't have experience in CNC programming, or the first time user of the ES-8A's R function, they may find that it is difficult to understand what is coordinate.

The coordinate is a pair of number which specify a position.

When using the ES-8A's R function, it is necessary to enter the coordinates of ARC's center, start point, end point and etc.. to let the ES-8A knows the geometry of the ARC to be machined.

During installation of the ES-8A, normally the service engineer will set the display direction same as the dial of the machine. For a typical knee type milling machine, the lead screw dial direction are as follows, therefore, DRO's display direction are also normally be set to the direction as per follows.

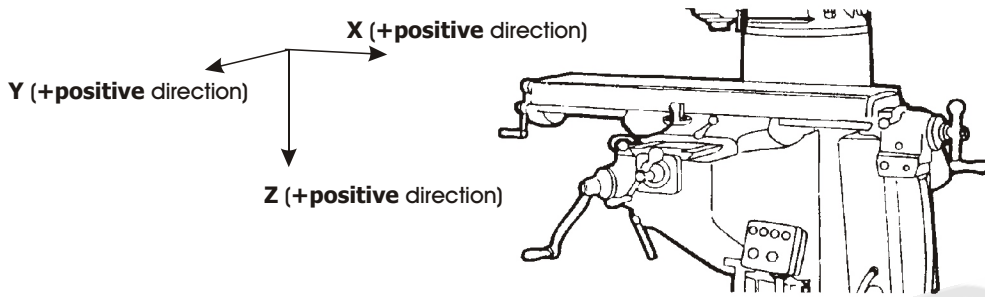

**-- NOTICE --**  
Coordinate have signs to specify it's relative location from ZERO

## Coordinate Example

Coordinate is a pair of number which specify the distance from the datum point ( ZERO position ), the number can be either be positive or negative depend on it's relative direction from ZERO position.

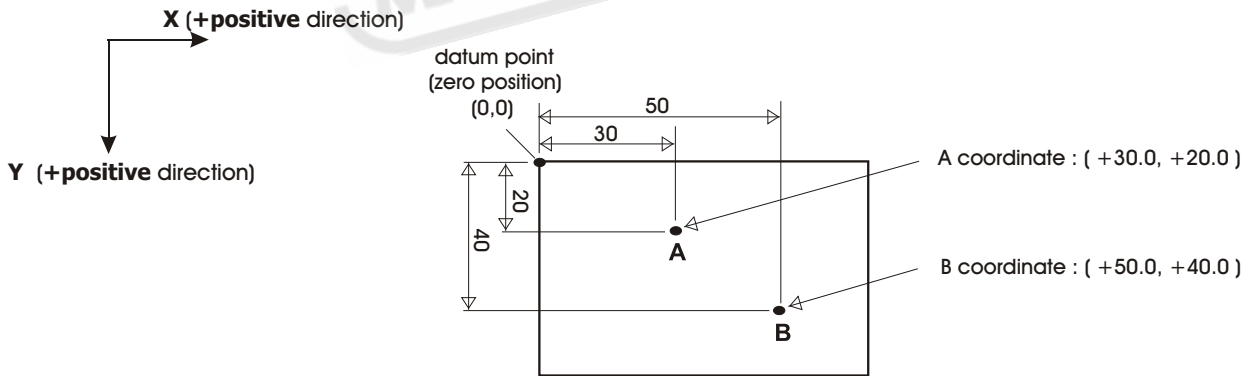

Example 1

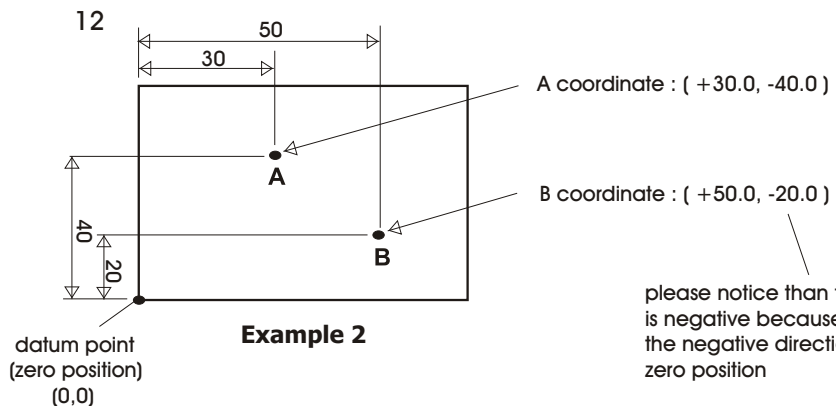

Example 2

please notice than the Y coordinate is negative because it located at the negative direction from the zero position

# R function

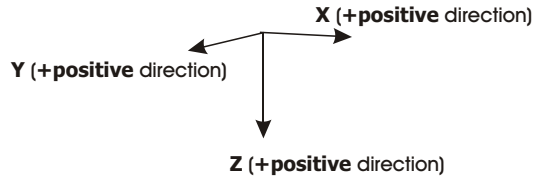

## Example 3

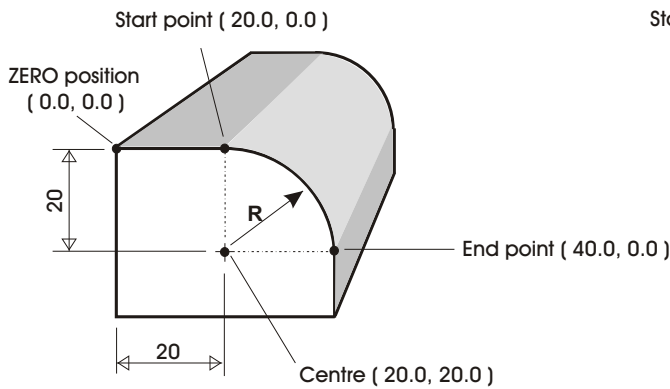

## Example 4

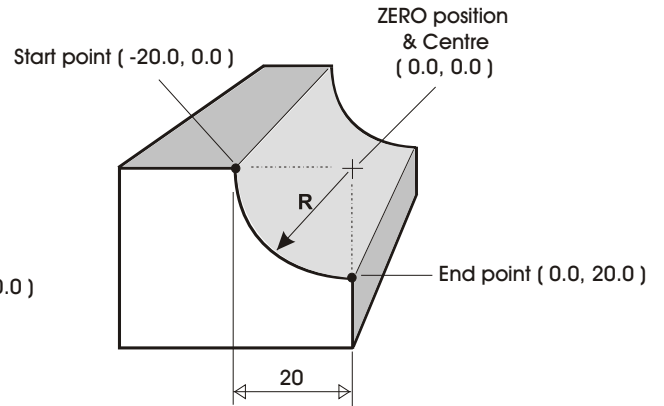

## Work Plane :

The ES-8A's R function allows operator to machine R in XY, XZ and YZ plane as per following picture shows.

When only 2 axis ES-8A is used, the ES-8A can calculate all the ARC tool positions on XZ & YZ work plane and assist the operator to posit the tool to the ARC machining points by a simulated Z position, the simulated Z position is showed on the message display of the ES-8A which shows the Z dial setting of the machine.

In the case of 3 axes DRO used, when the XZ or YZ plane ARC is to be machined, the X or Y axis machining positions along the ARC will follow the Z position of the machine automatically.

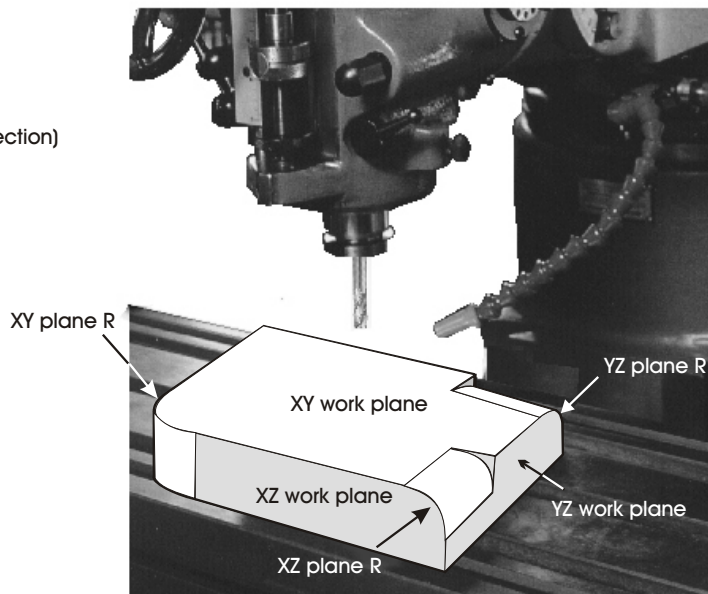
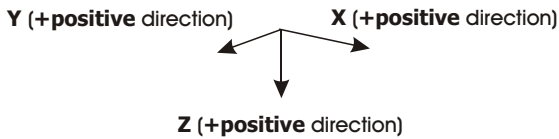

# R function

Following parameters needed to enter into the DRO for ARC machining.

1. Select the ARC work plane - **XY, XZ or YZ plane R**

2. R's Centre (**CENTRE**)

3. R's Radius (**R**)

4. R's Start point (**ST. PT.**)

5. R's End point (**End PT.**)

6. Tool Diameter (**TOOL DIA**)

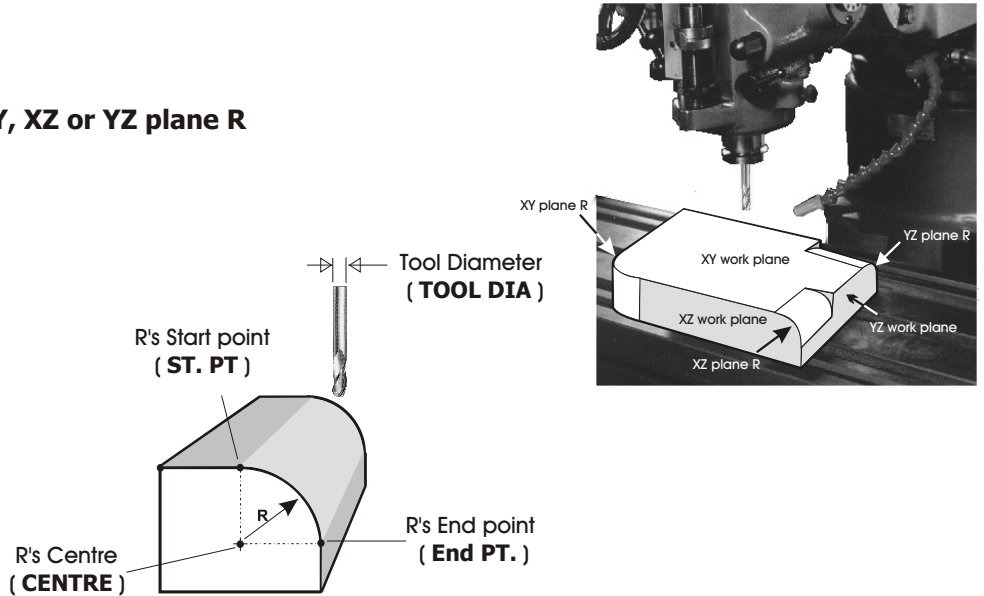

7. Select Tool Radius Compensation (**R+TOOL**) or (**R-TOOL**)

	( R+TOOL )	( R-TOOL )
<b>XZ / YZ plane R</b>		
<b>XY plane R</b>		

8. Machining STEP increments ( **Only when for 2 axes DRO is used or machining the XY plane R** )

Since in the 2 axes ES-8A, there is no Z axis available, in order to make the machining of XZ and YZ plane R possible, we need to simulate the Z axis position by mathematical method, also, we need to simulate the Z up/down increments by the UP or DOWN key press so that the ES-8A can calculate the XZ / YZ arc machining position accordingly, this parameter is to specify how the Z position increment when UP or DOWN key is pressed.

When machining the XZ and YZ plane R in 3 axes ES-8A, no need to enter this Machining STEP increments, it is because the ES-8A can calculate the X or Y machining positions and set those points to zero to guide the operator to machine the ARC according to the current Z position. In case the Z position are out of the ARC's Z position range, an warning message [ r. OU LI] - R is outside the Z limit is displaying on the Z axis of the ES-8A.

<b>XY plane R</b>	<b>XZ / YZ plane R ( for 2 Axes DRO only, not for 3 Axes DRO )</b>	
<p>For XY plane R, Max. distance between interpolated points is to be specified as the machining STEP increments</p> <p><b>MAX CUT=</b> max. distance between interpolated points</p>	<p>For XZ/YZ plane R, the Z STEP parameter is the Z step increments per UP or DOWN key press. The Z increment distance is fixed and specified by this parameter.</p> <p><b>Z STEP =</b> Fixed Z increments per UP or DOWN key press</p>	<p>For XZ/YZ plane R, if the R MODE parameter of SETUP is selected to be MAX CUT, the DRO will calculate the Z step increments per UP or DOWN key press so that the Max. distances between each machining step are approximately the same for a smoother ARC machining.</p> <p><b>MAX CUT=</b> max. distance between interpolated points</p>

# R function

## Example :

To machine an XZ plane R as per shown in diagram below

Following machining parameters have to enter into the DRO

1. Select the XZ plane R ..... for 2 Axes DRO ( **S.R - XZ** )  
..... for 3 Axes DRO ( **R -XZ** )
2. Centre ( **XZ CENTR** ) ..... X = 20.000 ; Z = 20.000
3. Radius ( **R** ) ..... 20.000
4. Start point ( **XZ ST. PT** ) ..... X=20.000 ; Z = 0.000
5. End point ( **XZ END P** ) ..... X = 40.000 ; Z = 20.000
6. Tool diameter ( **TOOL DIA** ) ..... 6.000
7. Tool Compensation - ( **R+TOOL** ) .... Actual ARC Radius = R + Tool Radius
8. Z increment per step ( **Z STEP** ) ..... 0.3mm ( for 2 Axes DRO only )  
( No Need for 3 Axes DRO )

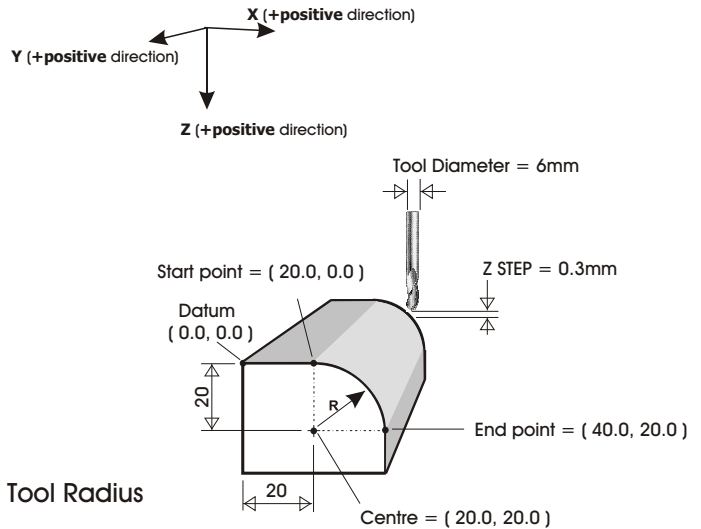

## Operation Example

In case 2 Axes ES-8A is used, we must first reset the Z Dial to simulate the initial Z position at the ARC's start point

\*\* Posit the Tool at start point of the ARC to be machined \*\*

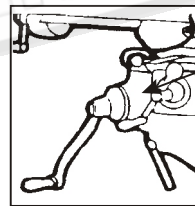
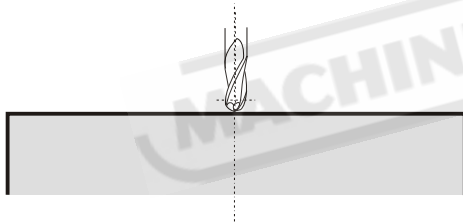

Set the Z axis Dial to ZERO ( 0.00 )

\*\*\*\* Only for 2 Axes DRO, not valid if a 3 Axes DRO is used \*\*\*\*

Step 1 : select work plane : XZ plane ( **S.R - XZ** ) for 2X DRO  
( **R - XZ** ) for 3X DRO

XY plane R

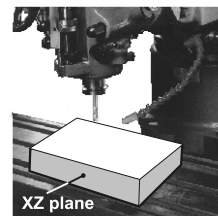
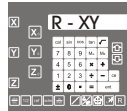

enter into R function

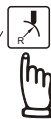

select work plane

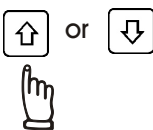

XZ plane R

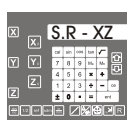

select XZ plane R

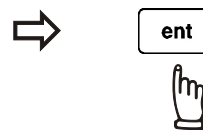

XZ plane R

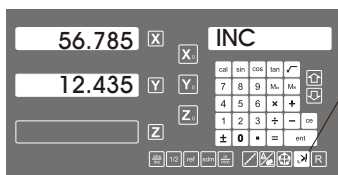
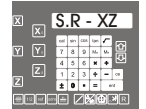

# R function

## Step 2 : enter the Centre's coordinate ( XZ CENTR )

centre coordinate ( XZ CENTR ) : X=20.000, Z=20.000

enter centre's coordinate ( XZ CENTR )

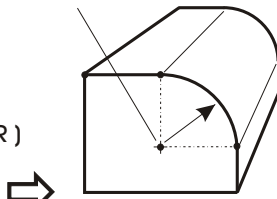
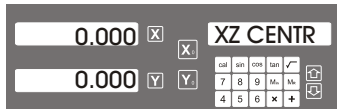

X 2 0 ent

Y 2 0 ent

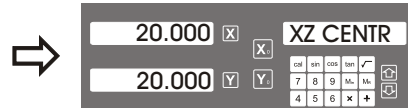

next step



in case of 2X DRO, since there is no Z axis use Y axis to enter Z axis centre coordinate

for 3X DRO, enter Z axis centre coordinate at Z axis

## Step 3 : enter the Radius ( R )

Radius ( R ) = 20.000mm

enter Radius ( R )

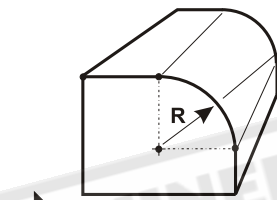
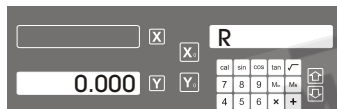

2 0 ent

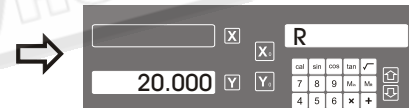

next step



## Step 4 : enter the Start point's coordinate ( XZ ST. PT )

start point's coordinate ( XZ ST. PT ) : X=20.000, Z=0.000

enter start point's coordinate ( XZ ST. PT )

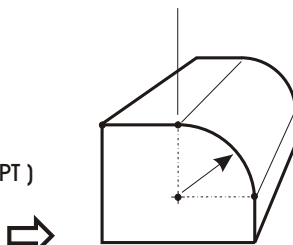
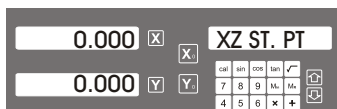

X 2 0 ent

Y 0 ent

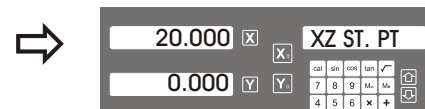

next step



in case of 2X DRO, since there is no Z axis use Y axis to enter Z axis Start point coordinate

for 3X DRO, enter Z axis Start point coordinate at Z axis



# R function

Step 5 : enter the End point's coordinate ( **XZ End P** )

End point's coordinate ( XZ ST. PT ) : X=40.000, Z=20.000

enter start point's coordinate ( XZ End P )

0.000	X	XZ End P
0.000	Y	

→

X	4	0	ent
Y	2	0	ent

→

40.000	X	XZ End P
20.000	Y	

→

next step

↓

in case of 2X DRO, since there is no Z axis use Y axis to enter Z axis End point coordinate

for 3X DRO, enter Z axis End point coordinate at Z axis

Step 6 : enter the Tool Diameter ( **TOOL DIA** )

Tool Diameter = 6mm

enter Tool diameter ( TOOL DIA )

	X	TOOL DIA
0.000	Y	

→

6	ent
---	-----

→

	X	TOOL DIA
6.000	Y	

→

next step

↓

Step 7 : select tool compensation direction ( **R+TOOL** )

( **R+TOOL** )

select ( **R+TOOL** )

↑

↓

→

X	X	R+TOOL
Y	Y	
Z	Z	

→

ent

→

( **R+TOOL** )

X	X	R+TOOL
Y	Y	
Z	Z	

→

next step

↓

( **R-TOOL** )

X	X	R-TOOL
Y	Y	
Z	Z	

If 2 axes ES-8A is used, please skip this page and go to the next two pages to continue the R parameters entry.

For 3 axes ES-8A, all the ARC parameters have been completely entered into the ES-8A, the ES-8A will entered into the three axes ARC machining mode as per follows.

### Three Axes ARC machining mode operation :

In the three axes ARC machining operation, the DRO will calculate the ARC profile according to the current Z axis position, and preset the X axis ( in case XZ plane R ) or Y axis ( in case of YZ plane R ) to 0.000 to guide the operator to machine the ARC profile.

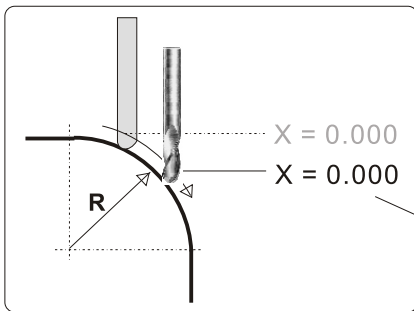

In this example, XZ plane R is selected, therefore, move the X axis until X display = 0.000 then the tool is posited on the ARC curve.

The display will **shift left** to signify it is not a normal coordinate display

Since the X axis is preset automatically with the Z movement, therefore, we call it AUTO R - XZ plane

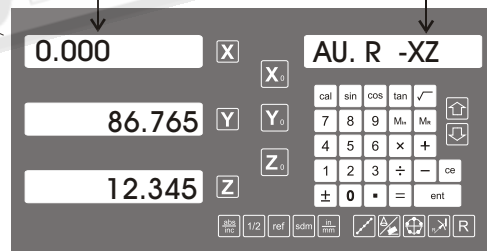

The operator can make Z axis increment to machine the ARC according to the surface finish they required.

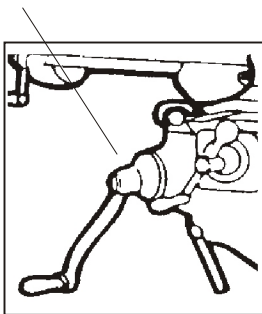

In case the operator posit the Z axis outside the R curvature, the DRO will display " r OU LI " - [ R Outside Z Limits ] in the Z axis display

the Z position located out of the ARC range

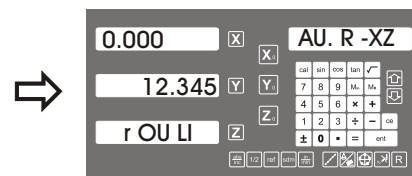

## R function - For 3 Axes ES-8A

Anytime the operator want to check or verify if the DRO's ARC calculation correct or not, or want to temporarily exit the ARC function cycle ( swap to normal XYZ display ). Operation procedure are as follows :

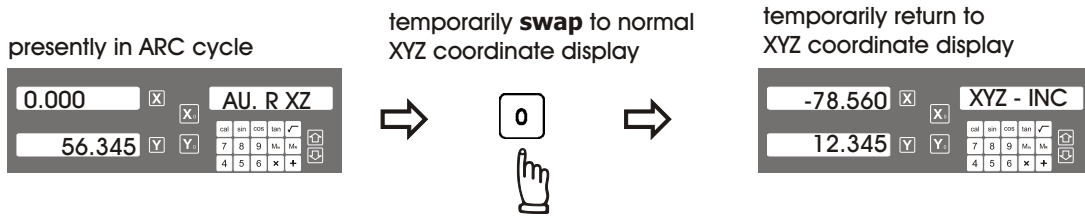

swap back to ARC machining cycle to continue the R machining process

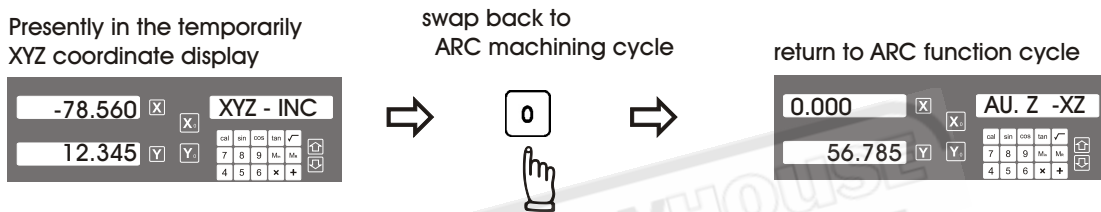

## Quit from the ARC machining Cycle

After the ARC machining operation is completed , to quit from the ARC function cycle, press the ARC button again.

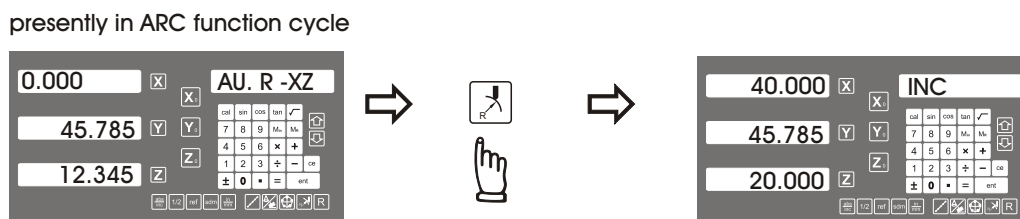

## R function - For 2 Axes ES-8A

The following procedure are for 2 axes ES-8A, not valid for 3 axis ES-8A.

### Step 8: enter the Z increment per step machining

This DRO provides two options on the Z increment per UP or DOWN key press, Operator can enter their selection in the R. MODE menu of the DRO's SETUP procedure.

#### Option 1 : Fixed Z step ( **Z STEP** )

under this option, the Z increment per step machining is fixed, since the ARC's curvature is vary with their Z position, operator have to use their experience to select different Z STEP increment during the ARC machining to get optimal and fastest machining.

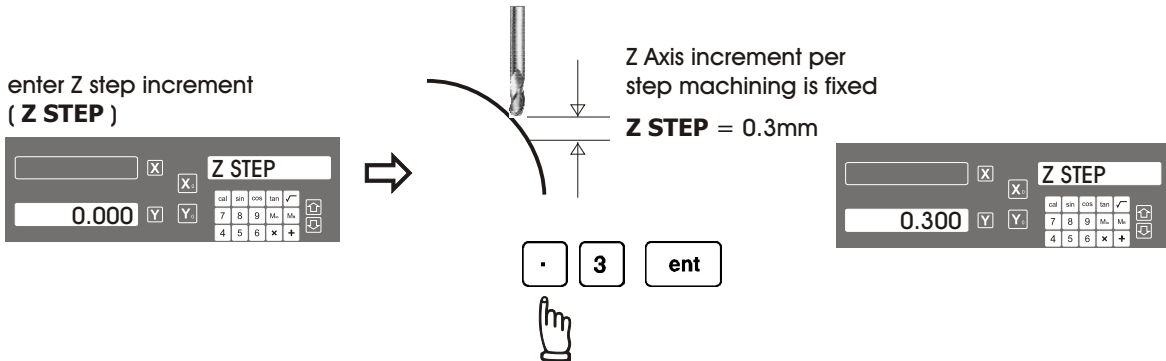

#### Option 2 : Maximum Cut ( **MAX CUT** )

under this option, the DRO will calculate the best possible Z increment per step machining according to the curvature of the ARC, to make the interpolated point approximately equal to the MAX CUT entered

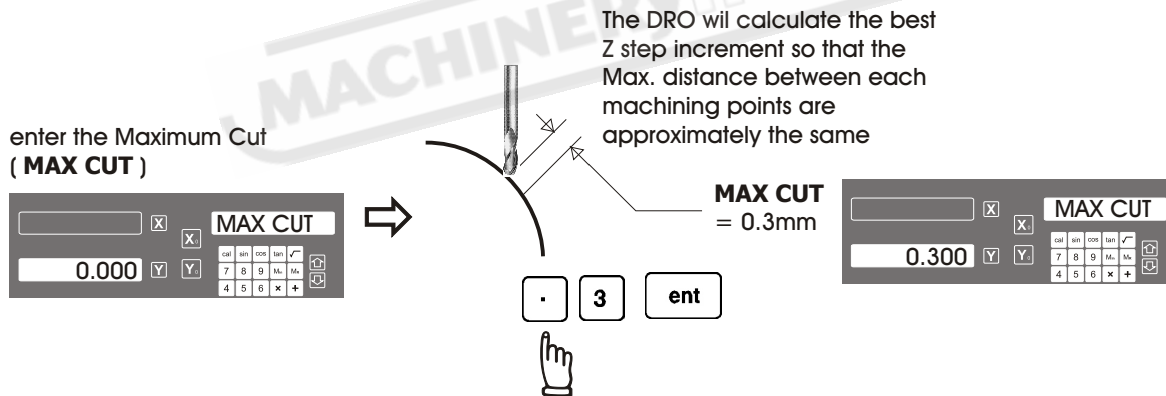

All R function machining parameters have already entered into the DRO, press the DOWN key to enter into two axis ARC machining mode

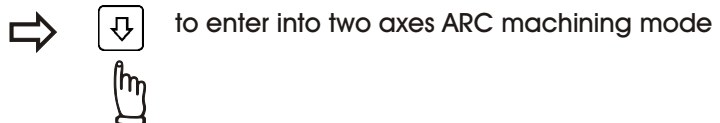

since two Axis ES-8A do not have Z Axis therefore, the DRI use UP / DOWN keys



and



to simulate the Z axis movement



- simulate Z axis move UP one step



- simulate Z axis move DOWN on step

before starting the ARC machining in two axes ARC machining mode, please make sure the tool is posited at the ARC starting point and Z axis dial is set to ZERO ( 0.00 )

**Two Axes ARC machining mode operation :**

During the XZ and YZ plane R machining, it is necessary to accurately posit the Z axis to obtain a precise Z position. However, there is no Z axis in two axis DRO. Therefore in order to guide the operator easily posit the Z axis during the ARC machining. DRO use the unused axis display to display the Z dial turn number and Z dial reading to guide the operator to posit the Z axis.

At the beginning of the ARC machining, the DRO will start and assume the Z axis dial at zero position with the tool posited at the starting point of the ARC, then press UP or DOWN key once to simulate Z axis move up or down the Z axis for one step, the corresponding Z dial turn number and Z dial reading will display on the unused axis. Operator just need to move the Z axis according to the dial reading display on this axis, then the correct Z axis height is reached.

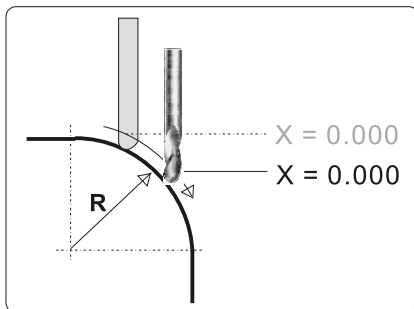

Move the X axis until display = 0.000 then the tool is posited on the ARC curvature

The display will **shift left** to signify it is not normal coordinate display

move the Z axis according to the dial setting displayed on Y axis

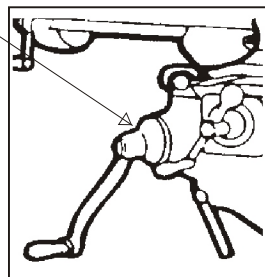

Z dial turn number

Z dial reading

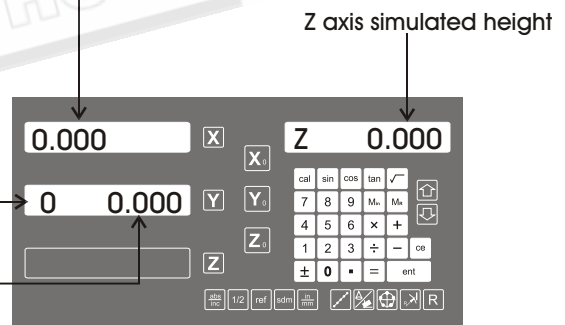

Display for 'Two axes ARC machining mode"

## R function - For 2 Axes ES-8A

Anytime the operator want to check or verify if the DRO's ARC calculation correct or not, or want to temporarily exit the ARC function cycle ( swap to normal XYZ display ). Operation procedure are as follows :

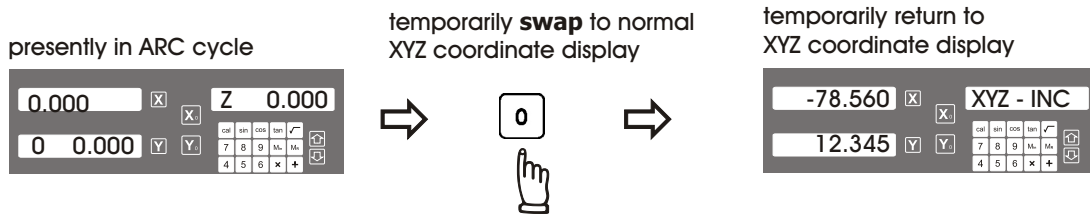

swap back to ARC machining cycle to continue the R machining process

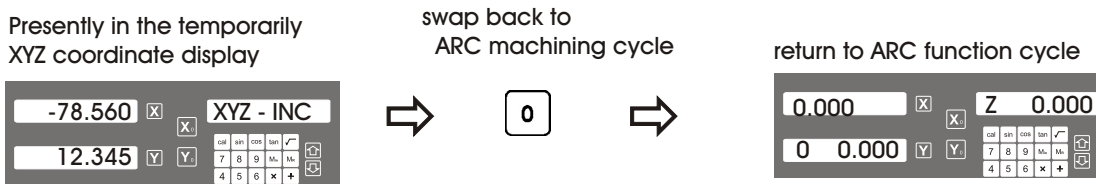

If fixed **Z STEP** option is chosen in the R MODE menu of SETUP , the **Z STEP** increment can be changed anytime during the ARC machining

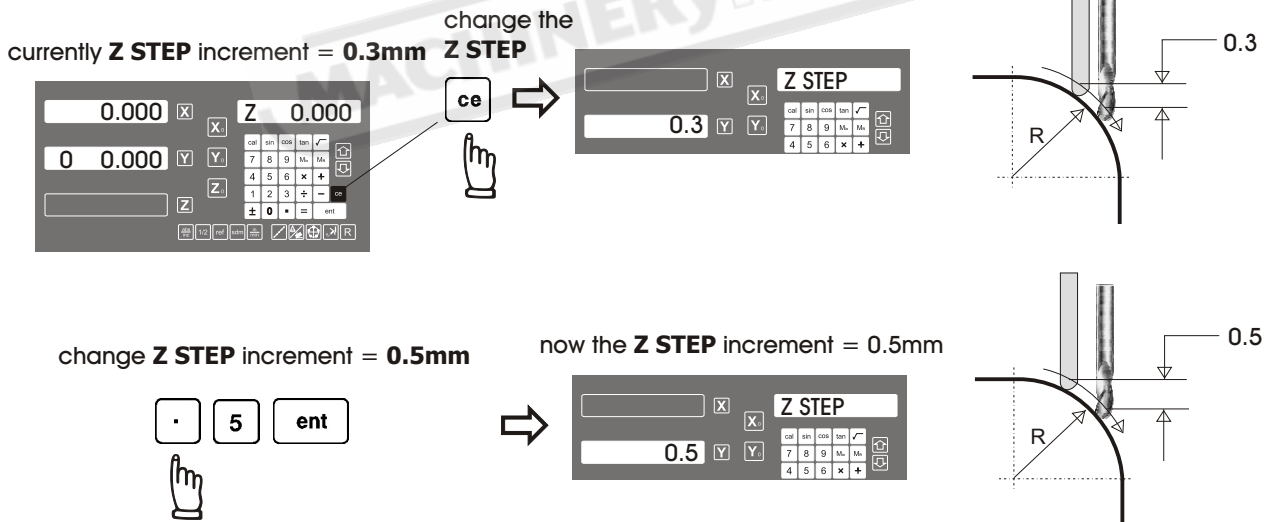

## Quit from the ARC machining Cycle

After the ARC machining operation is completed , to quit from the ARC function cycle, press the ARC button key again.

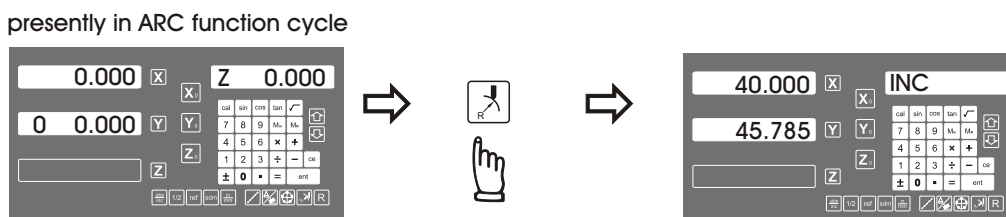

# R function - XY plane ARC

## Example :

To machine an XY plane R as per shown in digram below

Following machining parameters have to enter into the DRO

1. Select the XY plane R ..... ( **R -XY** )
2. Centre ( **XZ CENTR** ) ..... X = 20.000 ; Y = 20.000
3. Radius ( **R** ) ..... 20.000
4. Start point ( **ST. PT** ) ..... X = 20.000 ; Y = 0.000
5. End point ( **END PT** ) ..... X = 40.000 ; Y = 20.000
6. Tool diameter ( **TOOL DIA** ) ..... 6.000 mm
7. Tool Compensation - ( **R+TOOL** ) .... Actual ARC Radius  
= R + Tool Radius
8. Max cut between interpolated points ( **MAX CUT** ) ..... 0.3mm

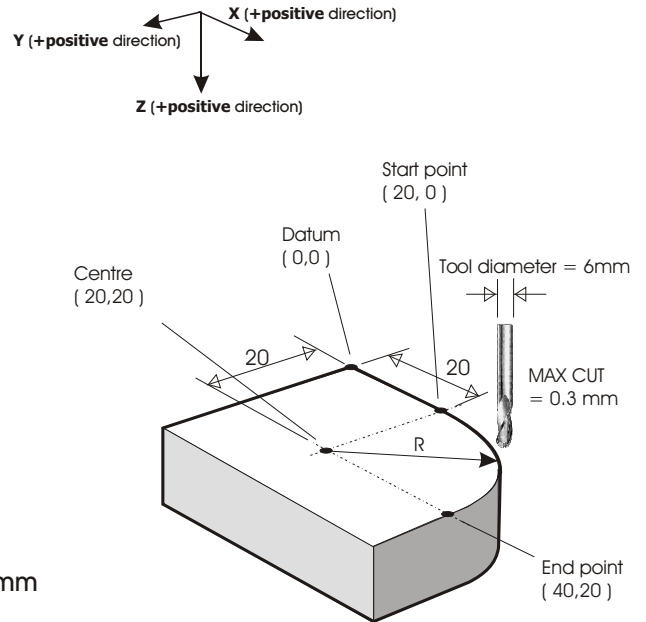

## Operation Example

**Step 1 :** select work plane : XY plane R : ( **R - XY** )

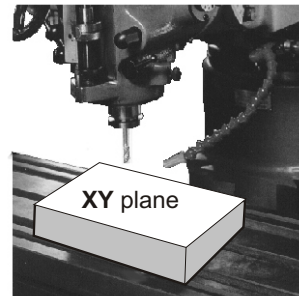
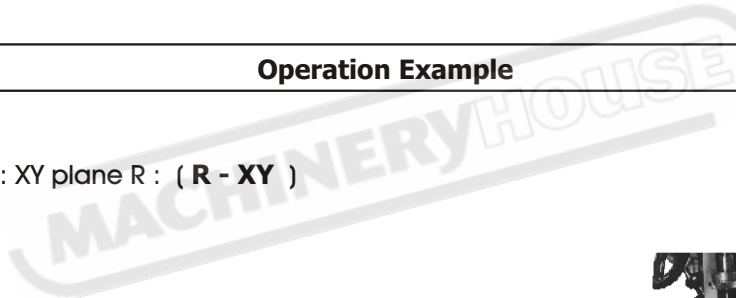

XY plane R

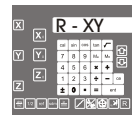

enter into R function

select work plane

XZ plane R

select XY plane R

XY plane R

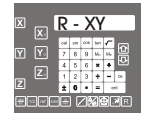
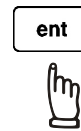
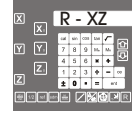
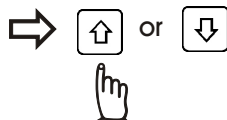
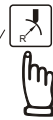
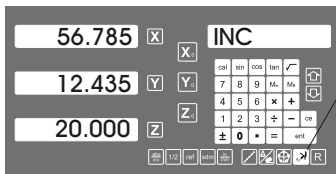

# R function - XY plane ARC

Step 2 : enter the Centre's coordinate ( XY CENTRE )

centre coordinate ( CENTRE ) : X=20.000, Y=20.000

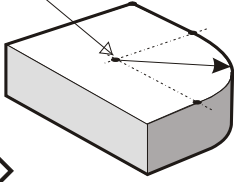

enter centre's coordinate ( XY CENTRE )

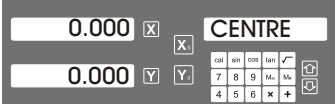

X 2 0 ent

Y 2 0 ent

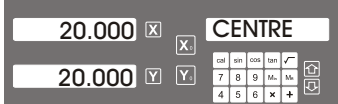

next step



in case of 2X DRO, since there is no Z axis use Y axis to enter Z axis centre coordinate

for 3X DRO, enter Z axis centre coordinate at Z axis

Step 3 : enter the Radius ( R )

Radius ( R ) = 20.000mm

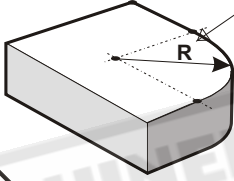

enter Radius ( R )

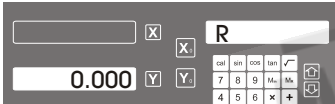

2 0 ent

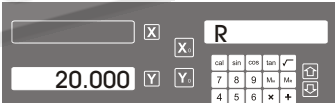

next step



Step 4 : enter the Start point's coordinate ( ST. PT )

start point's coordinate ( ST. PT ) : X=20.000, Y=0.000

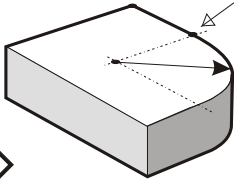

enter start point's coordinate ( ST. PT )

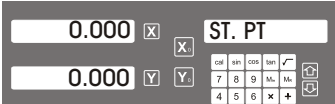

X 2 0 ent

Y 0 ent

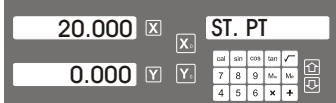

next step





## R function - XY plane ARC

Step 5 : enter the End point's coordinate ( **End. PT** )

End point's coordinate ( End. PT ) : X=40.000, Y=20.000

enter start point's coordinate ( End. PT )

0.000 X End. PT  
0.000 Y Y

X 4 0 ent  
Y 2 0 ent

40.000 X End. PT  
20.000 Y Y

next step

↓  
↓

Step 6 : enter the Tool Diameter ( **TOOL DIA** )

Tool Diameter = 6mm

enter Tool diameter ( TOOL DIA )

TOOL DIA  
0.000 Y Y

6 ent

TOOL DIA  
6.000 Y Y

next step

↓  
↓

Step 7 : select tool compensation direction ( **R+TOOL** )

( **R+TOOL** )

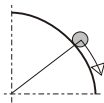
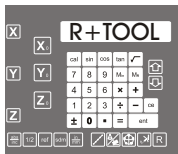

select ( **R+TOOL** )

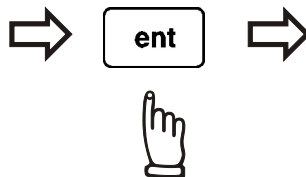

( **R+TOOL** )

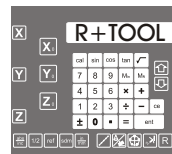

next step



( **R-TOOL** )

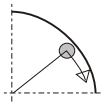
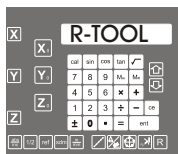

# R function - XY plane ARC

**Step 8 : enter Max. Cut between interpolated points ( MAX CUT )**

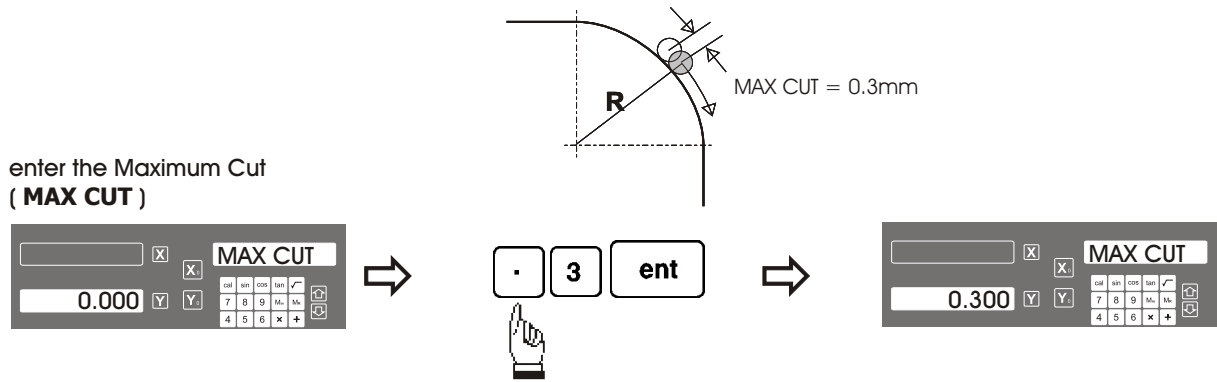

All R function machining parameters have already been entered into the DRO



to enter into ARC machining mode

Operator can



to select the interpolated points along the ARC curvature, then move the machine to XY displays = 0.000, 0.000 to arrive at the curvature position.

next R point



move the machine to XY displays = ( 0.000, 0.000 )

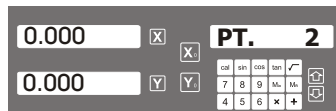

PT. 2 = interpolated point No. 2

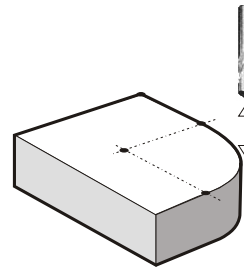

previous R point



move the machine to XY displays = ( 0.000, 0.000 )

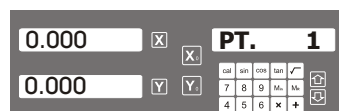

PT. 1 = interpolated point No. 1

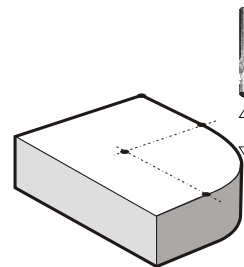

## R function - XY plane ARC

Anytime the operator want to check or verify if the DRO's ARC calculation correct or not, or want to temporarily exit the ARC function cycle ( swap to normal XYZ display ). Operation procedure are as follows :

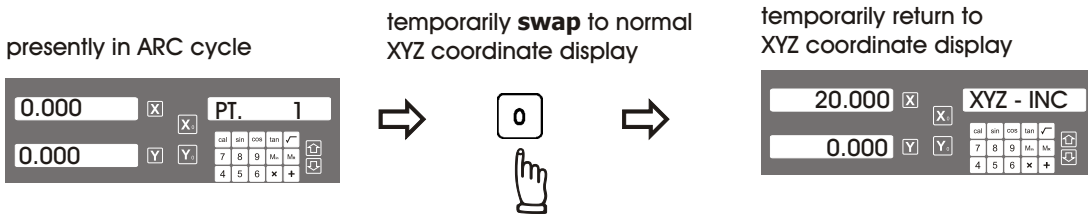

swap back to ARC machining cycle to continue the R machining process

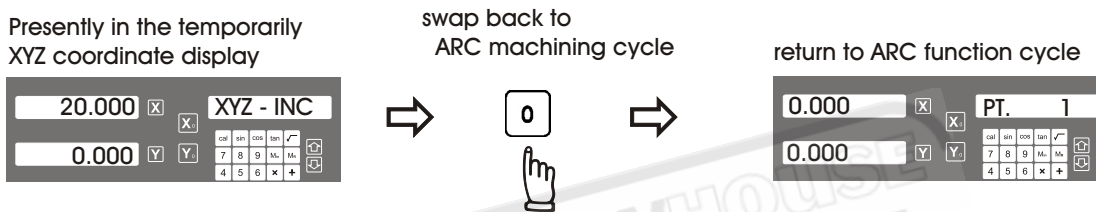

## Quit from the ARC machining Cycle

After the ARC machining operation is completed , to quit from the ARC function cycle, press the ARC button key again.

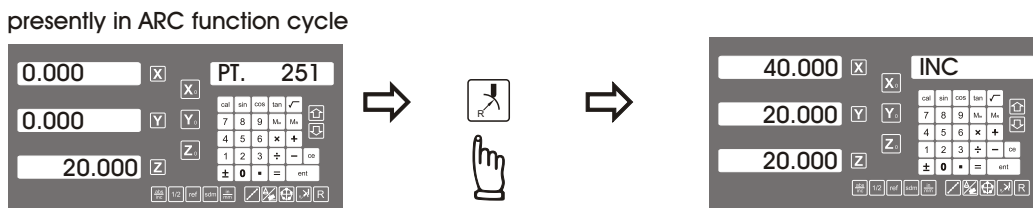

# Simplified R function

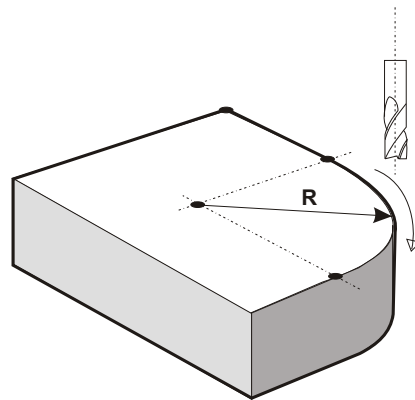
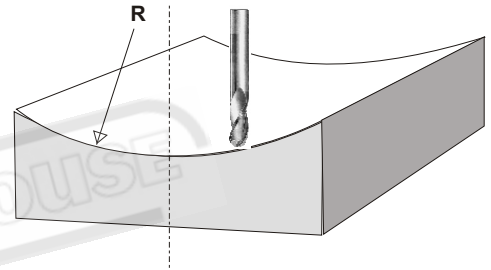
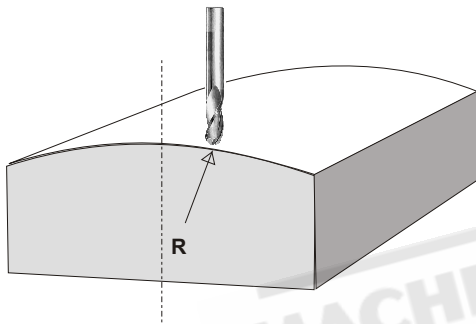

## Simplified R Function

**Function :** The R function of the ES-8A is designed to machine simple ARC, in fact, after concluded from years of our experience, we found that over 95% of the case, most of our customers just use this ES-8A to machine very very simple ARC. Most of our customers found that the entry of machining parameters in the ARC function is quite complicated to them.

Therefore, it comes to an requirement that we must provide a very simple to use R function, so that the operator can handle it in a very very short time.

After a work survey, we found that in majority of cases, only eight types of simple ARC are normally used in the ARC machining. Therefore, this ES-8A have built in those 8 types of commonly used ARCs, operator just select the type of R they needed to machine, input the Radius, tool dia, and ( for the 2 axes ES-8A, the Z axis increment per machining step ), then they can start the R machining right away.

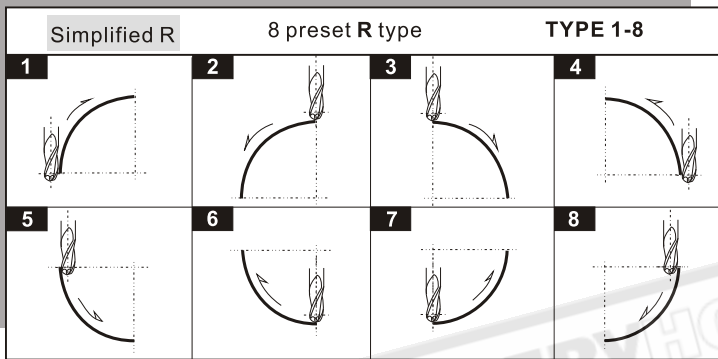

using ball nose mill cutter to machine XZ/YZ plane R

using 4 flute End Mill to machine XZ/YZ plane R

please notice that when using flat end mill to machine R, as we are actually using the tool's sharp corner for cutting, therefore the TOOL DIA must be set to 0.000

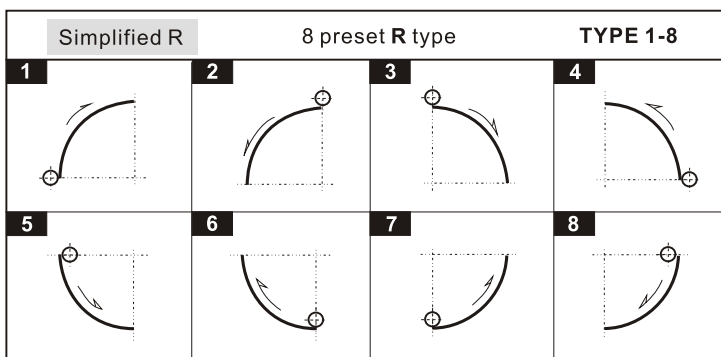
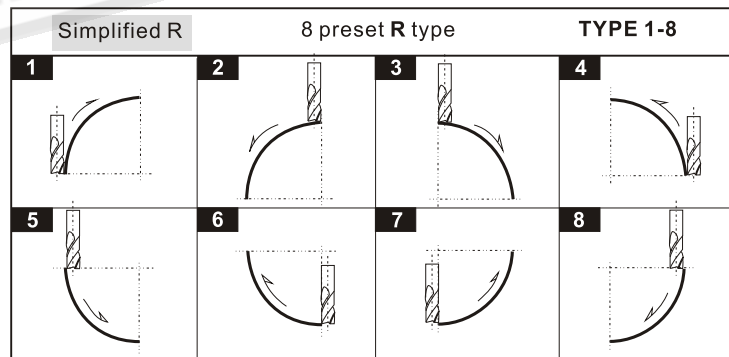

Using two flute ( SLOT DRILL ) for XY plane R

## Simplified R Function

In case 2 Axes ES-8A is used, we must first reset the Z Dial to simulate the initial Z position at the ARC's start point

**\*\* Posit the Tool at start point of the ARC to be machined \*\***

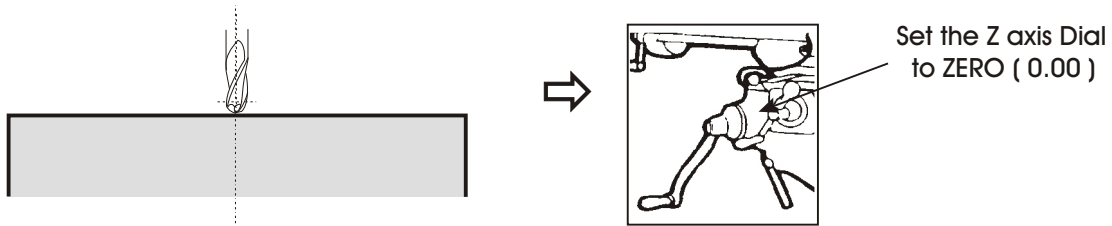

**\*\*\*\* Only for 2 Axes DRO, not valid if a 3 Axes DRO is used \*\*\***

### Following parameters needed to enter into the DRO for simplified R machining

1. Select the work plane - XY, XZ or YZ plane R

2. Select the R type ( **R type** ) - Type 1 to 8

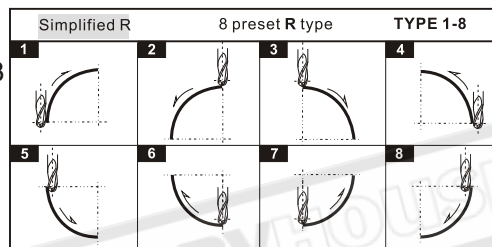

3 Input R's Radius ( **R** )

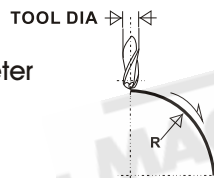

4. Enter to Tool Diameter ( **TOOL DIA** )

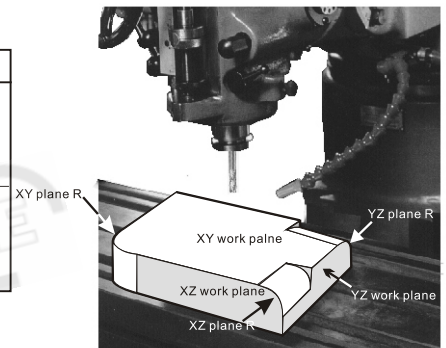

5. Machining STEP increments ( Only when for 2 axes ES-8A is used or machining the XY plane R )

Since in the 2 axes ES-8A, there is no Z axis available, in order to make the machining of XZ and YZ plane R possible, we need to simulate the Z axis position by mathematical method, also, we need to simulate the Z up/down increments by the UP or DOWN key press so that the DRO can calculate the XZ / YZ arc machining position accordingly, this parameter is to specify how the Z position increment when UP or DOWN key is pressed.

When machining the XZ and YZ plane R in 3 axes ES-8A, no need to enter this Machining STEP increments, it is because the DRO can calculate the X or Y machining positions and set those points to zero to guide the operator to machine the ARC according to the current Z position. In case the Z position are out of the ARC's Z position range, an warning message [ r. OU LI] - R is outside the Z limit is displaying on the Z axis of the ES-8A.

XY plane R	XZ / YZ plane R ( for 2 Axes ES-8A only, not for 3 Axes ES-8A )	
<p>For XY plane R, Max. distance between interpolated points is to be specified as the machining STEP increments</p> <p style="text-align: center;"><b>MAX CUT=</b> max. distance between interpolated points</p>	<p>For XZ/YZ plane R, the Z STEP parameter is the Z step increments per UP or DOWN key press. The Z increment distance is fixed and specified by this parameter.</p> <p style="text-align: center;"><b>Z STEP =</b> Fixed Z increments per UP or DOWN pkey press</p>	<p>For XZ/YZ plane R, if the R MODE parameter of SETUP is selected to be MAX CUT, the DRO will calculate the Z step increments per UP or DOWN key press so that the Max. distances between each machining step are approximately the same for a smoother ARC machining.</p> <p style="text-align: center;"><b>MAX CUT=</b> max. distance between interpolated points</p>

# Simplified R Function

## Example :

To machine a copper electrode as shown which have an ARC of R=200mm

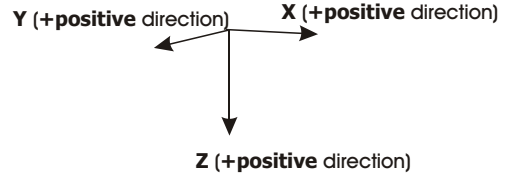
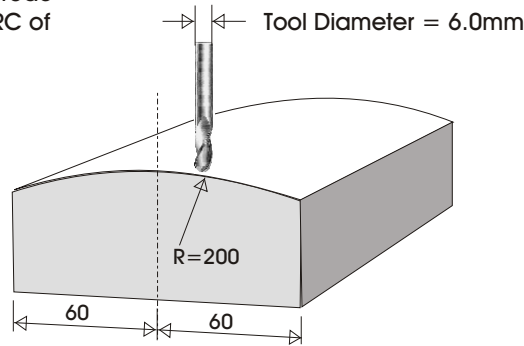

## Operation procedure

Because The ES-8A's XZ/YZ can only machine an ARC which have less than 90 degree, therefore, it is necessary to divide this arc machining into two parts

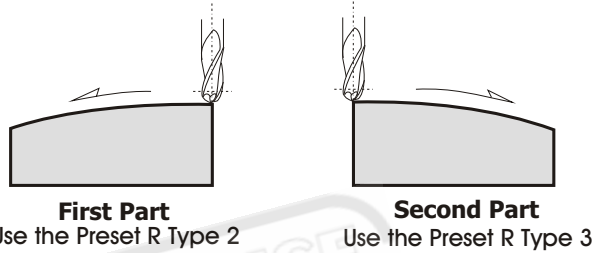

posit the tool at the ARC start point (surface of the work piece centre in this case)

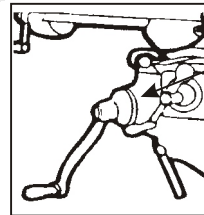
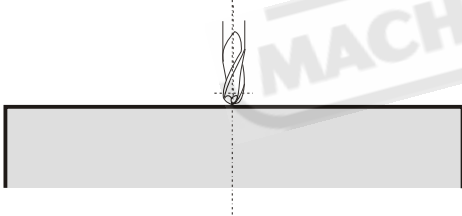

Step 1 : select work plane : XZ plane ( S.R - XZ ) for 2X DRO ( R - XZ ) for 3X DRO

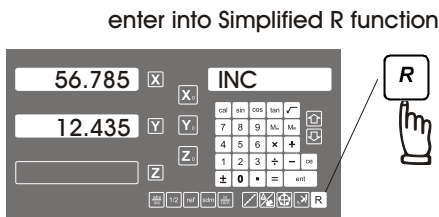

enter into Simplified R function



select work plane

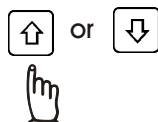

XY plane R

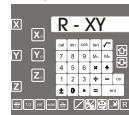

XZ plane R



YZ plane R

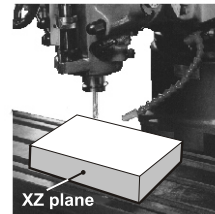

select XZ plane R

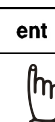

XZ plane R



# Simplified R Function

**Step 2 : select preset R type ( TYPE 1 - 8 )**

select R type ( TYPE 1-8 )

For the first part, select preset R type 2 ( TYPE = 2 )

Simplified R		8 preset R type		TYPE 1-8	
1		2		3	
4		5		6	
7		8			

next step

2 ent

**Step 3 : enter Radius( R )**

Radius ( R ) = 200.000

enter Radius ( R )

R = 200

2 0 0 ent

next step

**Step 4 : enter Tool Diameter ( TOOL DIA )**

Tool Diameter = 6.000

enter Tool diameter ( TOOL DIA )

6 ent

next step



## Simplified R Function - For 3 Axes ES-8A

**If 2 axes ES-8A is used, please skip this page and go to the next two pages to continue the R parameters entry.**

For 3 axes ES-8A, all the ARC parameter have been completely entered into the ES-8A, the ES-8A will entered into the three axes ARC machining mode as per follows.

### Three Axes ARC machining mode operation :

In the three axes ARC machining operation, the ES-8A will calculate the ARC profile according to the current Z axis position, and preset the X axis ( in case XZ plane R ) or Y axis ( in case of YZ plane R ) to 0.000 to guide the operator to machine the ARC profile.

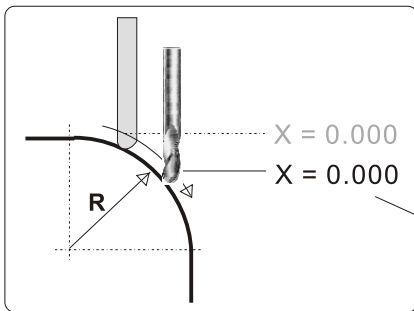

In this example, XZ plane R is selected, therefore, move the X axis until X display = 0.000 then the tool is posited on the ARC curve.

The display will **shift left** to signify it is not a normal coordinate display

Since the X axis is preset automatically with the Z movement, therefore, we call it AUTO R - XZ plane

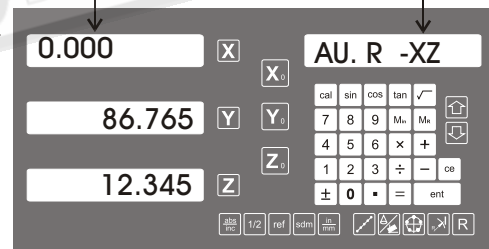

The operator can make Z axis increment to machine the ARC according to the surface finish they required.

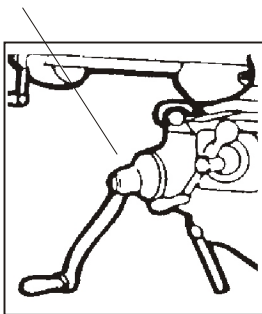

In case the operator posit the Z axis outside the R curvature, the DRO will display " **r OU LI** " - [ **R Outside Z Limits** ] in the Z axis display

the Z position located out of the ARC range

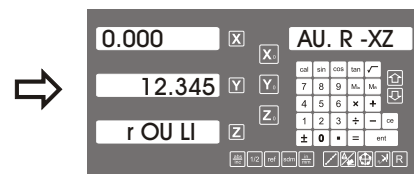

## Simplified R Function - For 3 Axes ES-8A

Anytime the operator want to check or verify if the ES-8A's ARC calculation correct or not, or want to temporarily exit the ARC function cycle ( swap to normal XYZ display ). Operation procedure are as follows :

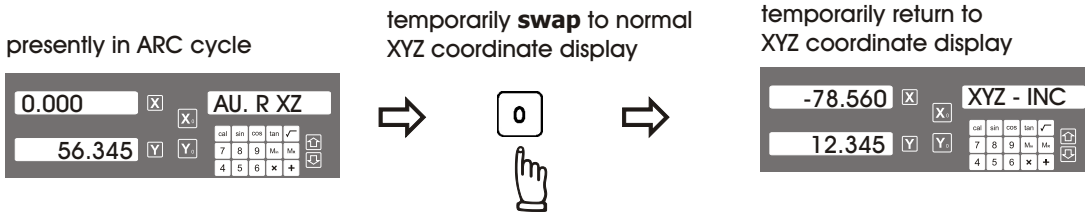

swap back to ARC machining cycle to continue the R machining process

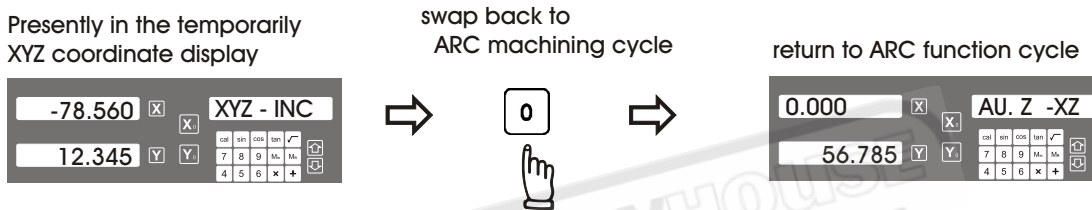

### Quit from the ARC machining Cycle

After the ARC machining operation is completed , to quit from the ARC function cycle, press the ARC button again.

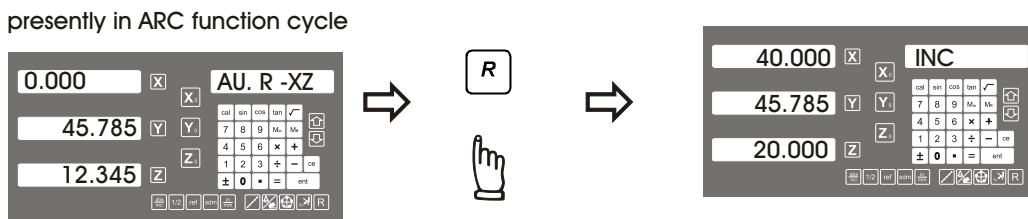

## Simplified R Function - For 2 Axes DRO

**The following procedure are for 2 axes DRO, not valid for 3 axis DRO.**

**Step 5:** enter the Z increment per step machining

This DRO provides two options on the Z increment per UP or DOWN key press, Operator can enter their selection in the R. MODE menu of the DRO's SETUP procedure.

**Option 1 : Fixed Z step ( Z STEP )**

under this option, the Z increment per step machining is fixed, since the ARC's curvature is vary with their Z position, operator have to use their experience to select different Z STEP increment during the ARC machining to get optimal and fastest machining.

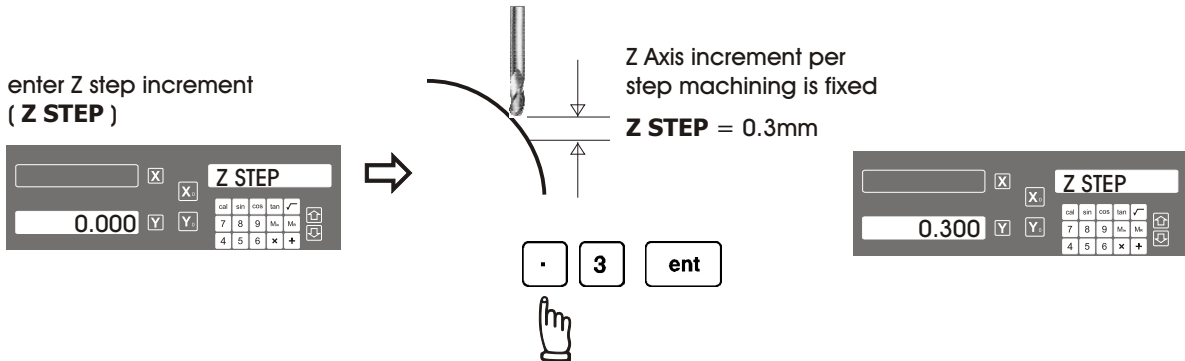

**Option 2 : Maximum Cut ( MAX CUT )**

under this option, the DRO will calculate the best possible Z increment per step machining according to the curvature of the ARC, to make the interpolated point approximately equal to the MAX CUT entered

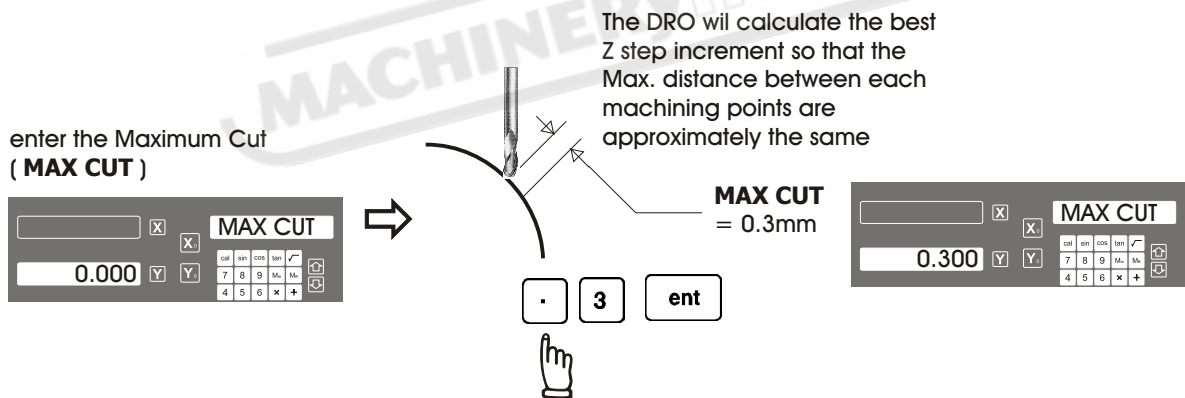

All R function machining parameters have already entered into the DRO, press the DOWN key to enter into two axis ARC machining mode

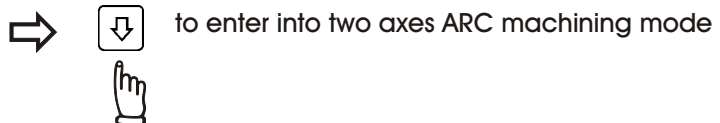

since two Axis DRO do not have Z Axis therefore, the DRI use UP / DOWN keys and to simulate the Z axis movement

- simulate Z axis move UP one step      - simulate Z axis move DOWN on step

before starting the ARC machining in two axes ARC machining mode, please make sure the tool is posited at the ARC starting point and Z axis dial is set to ZERO ( 0.00 )

## Simplified R Function - For 2 Axes DRO

### Two Axes ARC machining mode operation :

During the XZ and YZ plane R machining, it is necessary to accurately posit the Z axis to obtain a precise Z position. However, there is no Z axis in two axis DRO. Therefore in order to guide the operator easily posit the Z axis during the ARC machining. DRO use the unused axis display to display the Z dial turn number and Z dial reading to guide the operator to posit the Z axis.

At the beginning of the ARC machining, the DRO will start and assume the Z axis dial at zero position with the tool posited at the starting point of the ARC, then press UP or DOWN key once to simulate Z axis move up or down the Z axis for one step, the corresponding Z dial turn number and Z dial reading will display on the unused axis. Operator just need to move the Z axis according to the dial reading display on this axis, then the correct Z axis height is reached.

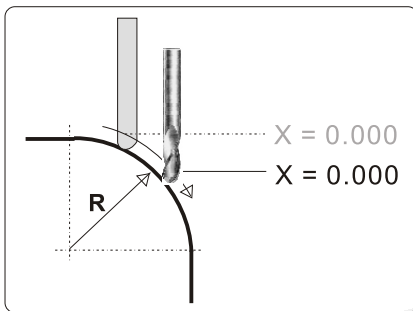

Move the X axis until display = 0.000  
then the tool is posited on the ARC curvature

The display will **shift left** to signify  
it is not normal coordinate display

Z axis simulated height

move the Z axis  
according to the dial  
setting displayed  
on Y axis

Z dial turn number

Z dial reading

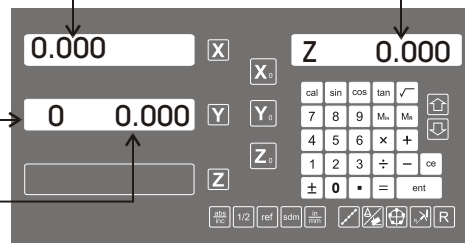

Display for 'Two axes ARC machining mode'

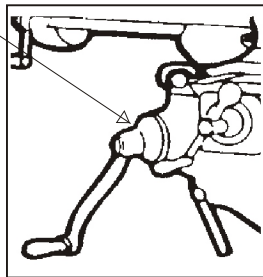

## Simplified R Function - For 2 Axes DRO

Anytime the operator want to check or verify if the DRO's ARC calculation correct or not, or want to temporarily exit the ARC function cycle ( swap to normal XYZ display ). Operation procedure are as follows :

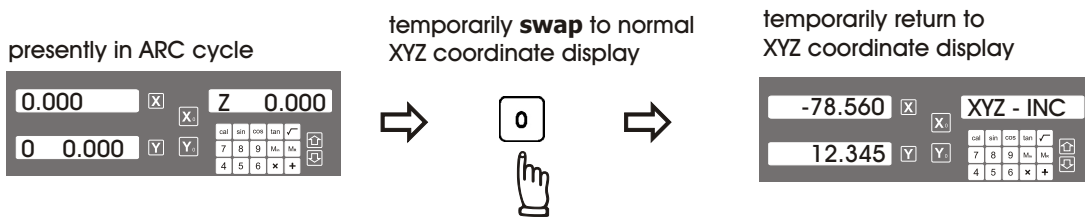

swap back to ARC machining cycle to continue the R machining process

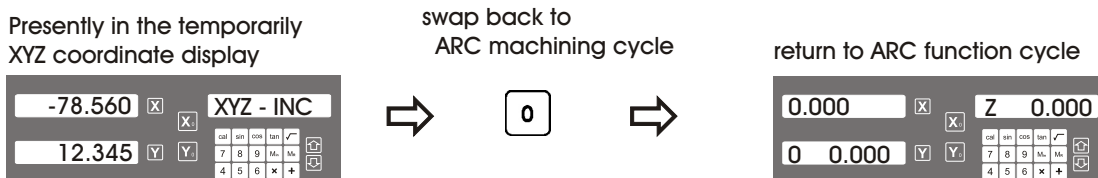

If fixed **Z STEP** option is chosen in the R MODE menu of SETUP , the **Z STEP** increment can be changed anytime during the ARC machining

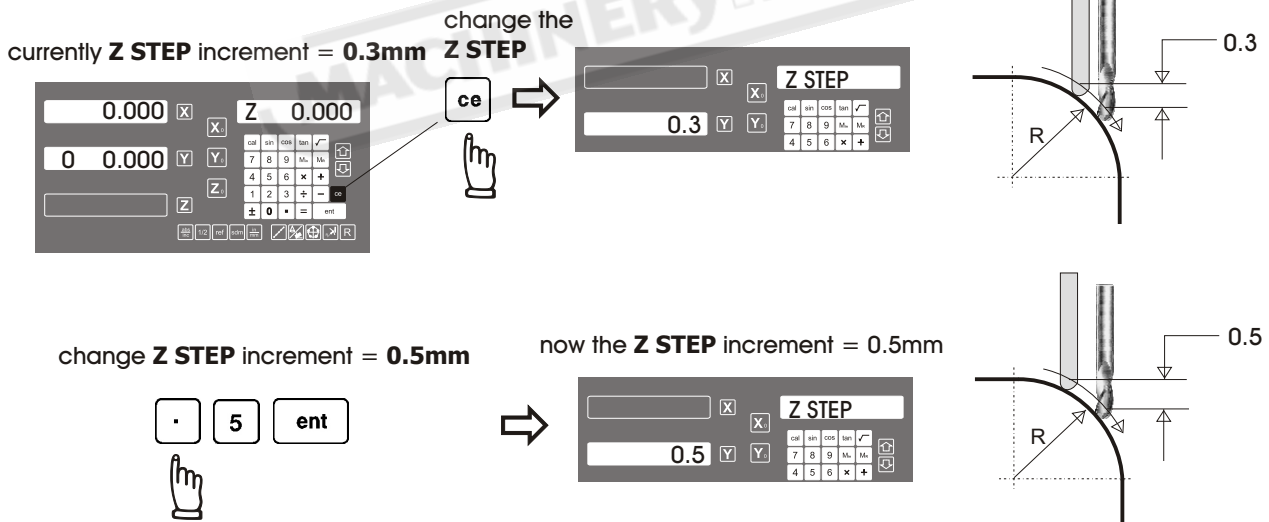

## Quit from the ARC machining Cycle

After the ARC machining operation is completed , to quit from the ARC function cycle, press the simplified R button key again.

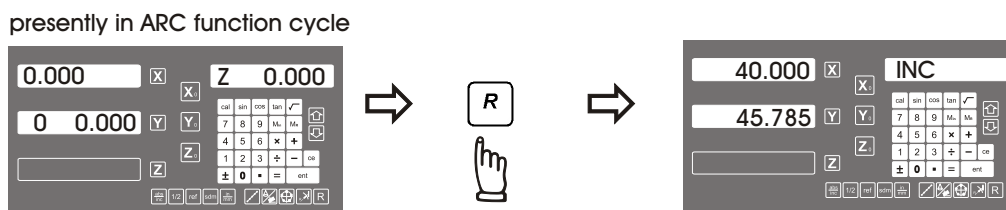

---

# Shrinkage Calculation

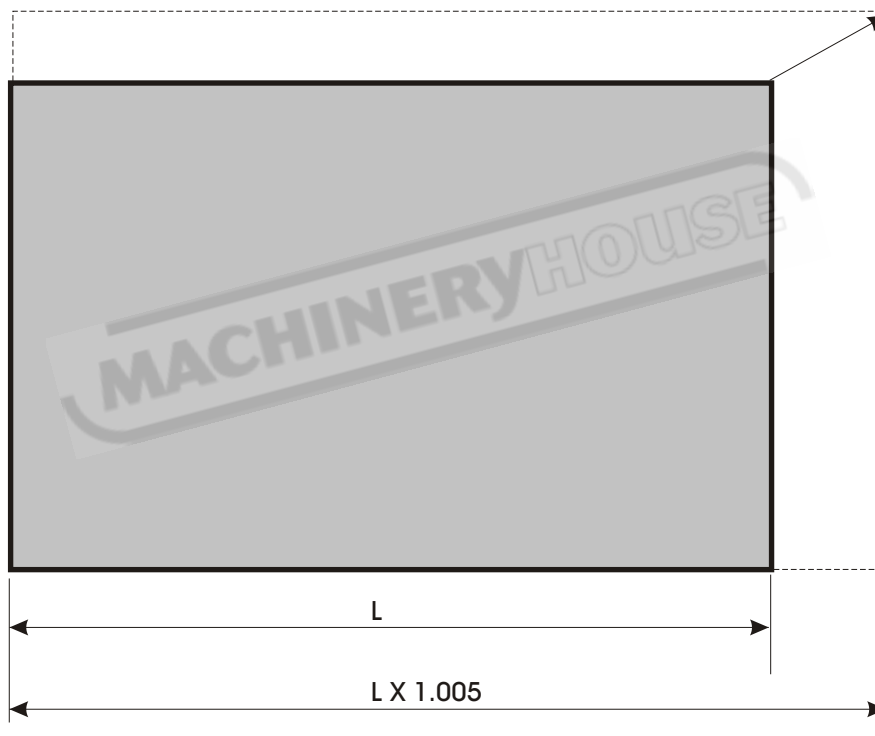

## Shrinkage Calculation

**Function :** The plastic materials will shrink during the cooling in the plastic injection process, therefore, in the mould making for plastic injection, the mould maker have to take the shrink of diemensions into account. The dimension of the mould cavity have to be expanded or reduced according to the **shrink factor** of the material, i.e. for normal ABS, the shrink factor is 1.005.

Normally, the mould maker have to calculate all the reduced or expanded dimensions in prior to the actual machining, marking down the dimensions on the drawings. The pitfalls of this method are as follows.

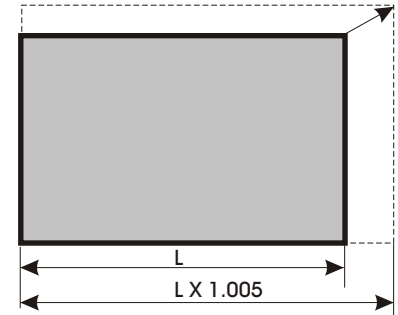

- 1) It is a very time consuming process
- 2) since there are a lot of calculations, it is inevitable that some calculation mistakes, or incomplete calculations ( some calculations are omitted by mistake ) occurs. There is also no easy method of verifying the calculated dimensions and it is too easy to make mistake, it is a very heavy psychological stress to the operator.
- 3) If any mistake happen, it is quite a big cost to fix especially after the mould hardened.

ES-8A provides a practical Shrinkage calculation function to assist the mould maker to calculate the reduced or expaned dimension, and also allow the mould maker to verify the expaned / reduced dimension very very easily.

## Operation procedure

1. Enter the Shrink Factor into the ES-8A

All the expanded / reduced dimensions in the shrinkage calculation function are actually the multiply or division of the dimension to the **shrink factor**, therefore, it is the most vital to enter the correct shrink factor in piror to the use of the shrinkage calculation function. Different plastic material have different shrink factor. The operator must enter the correct shrink factor according to the plastic material they are currently making the mould for.

**Example :** To enter the shrink factor of ( ABS plastic ), the shrink factor is 1.005

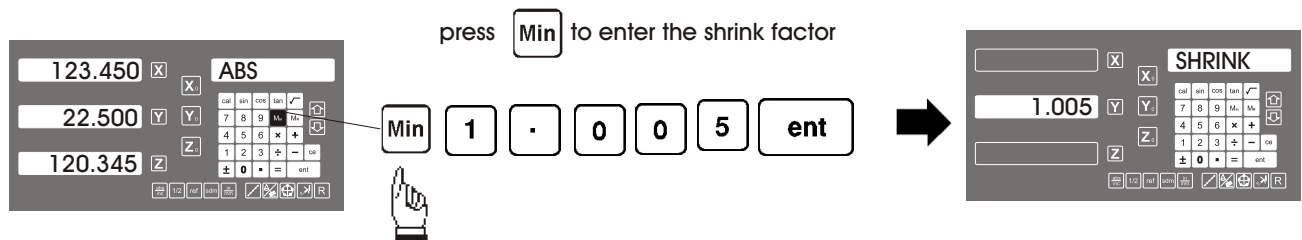

# Shrinkage Calculation

## 2. Shrinkage Calculations

ES-8A provides a very easy-to-use shrinkage calculation function of which allow the operator to calculate the expanded or reduced dimension very easily.

It is virtually not possible to have a mould drawing that have 100% completed and corrected expanded or reduced dimensions. The shrinkage calculation function is a very convenient function to be used in the situation that there are some missed calculations in the mould drawings, It allows operator to re-calculate the expanded or reduced dimension in a very very simple way. It also provides an easy method for the operator to verify the calculated dimensions that marked in the drawings.

**Shrinkage calculation KEYS :** + for expand calculation      - for reduce calculation

**Example :** To calculate the expanded dimension of 27mm

123.450 X

22.500 Y

34.565 Z

→

2

7

+

→

\* 27

\* 27.135

27mm expanded =  $27 \times 1.005 = 27.135$   
calculated result will be displayed in the message window

**Example :** To calculate the reduced dimension of 27mm

123.450 X

22.500 Y

34.565 Z

→

2

7

-

→

\* 27

\* 26.886

27mm expanded =  $27 / 1.005 = 26.886$   
calculated result will be displayed in the message window

**Example :** To calculate the expanded dimension of current X axis displayed dimension

123.450 X

22.500 Y

34.565 Z

ABS

→

X

+

→

X 124.067

The current position of X axis is 123.450, therefore,  
 $123.450 \text{ expands} = 123.450 \times 1.005 = 124.067$ .  
calculated result will be displayed in the message window



# Shrinkage Calculation

## 3. Shrinkage Compensation

When the operator is familiar with the DRO's shrinkage function, instead of calculating all expanded / reduced dimensions and marking them onto the drawings, he also can use the shrinkage compensation feature of the DRO which expand and reduce all displayed dimensions according to the multiply or division of the shrink factor, no need to calculate all work dimensions one by one.

Most mould makers insist that they have more confidence by calculating all shrunk dimensions in prior to actual machining and mark those dimensions on the drawing, the DRO's shrinkage compensation can provide a very efficient way for the mould maker to verify the calculated dimension by switching between the actual, expanded, reduced dimensions for just only a single key press !

**Shrinkage compensation KEYS :**  for expand calculation

 for reduce calculation

**Example :** To compensate by Expand, so that the DRO's actual displayed dimension are expanded by the ratio of the **shrink factor**.

When the ES-8A is in Shrinkage Compensation display mode, the displayed dimensions in all axes are either "expanded" or "reduced" by the ratio of shrink factor.

To remind the operator that the ES-8A is in Shrinkage Compensation mode, the message display will displaying :

- 1) The message of "+ SHRINK" and keep flashing
- 2) Give a beep sound for every 10 sec.
- 3) All DRO functions are disabled

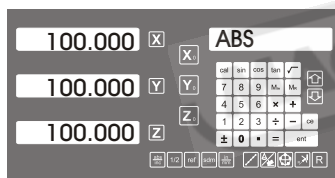

Actual Dimension display

Expand

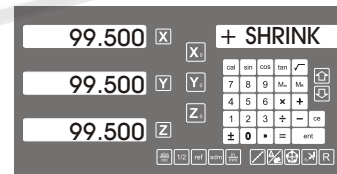

Shrinkage Compensated display

The displayed dimension are now divided by the **shrink factor** ( 1.005 in this example )

**Example :** To compensate by Reduce, so that the DRO's actual displayed dimension are reduced by the ratio of the **shrink factor**.

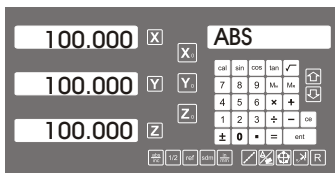

Actual Dimension display

Reduce

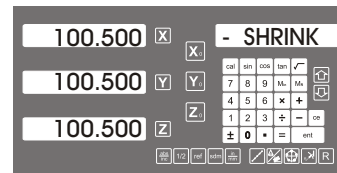

Shrinkage Compensated display

The displayed dimension are now multiply by the **shrink factor** ( 1.005 in this example )

## Shrinkage Calculation

To cancel the shrinkage compensation mode display, press **ce** to return to normal dimension display

currently in **shrinkage compensation** display

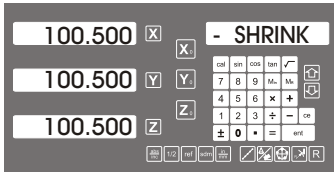

return to normal display

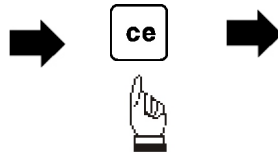

normal actual dimension display

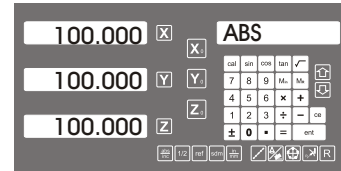

MACHINERYHOUSE

# Shrinkage Calculation

**Example :** To drill the following holes in the plastic injection mould

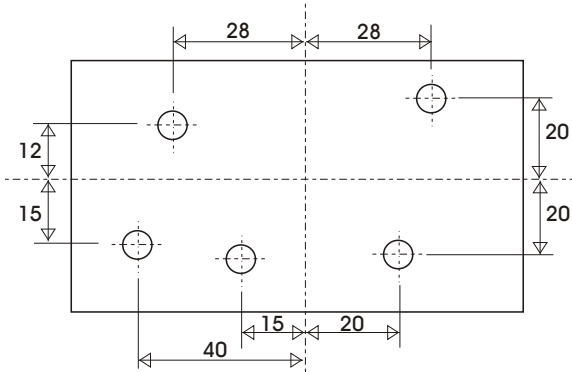

Because the plastic material will shrink when it cool down after the plastic injection process, the dimensions of the holes in the mould have to be expanded according to the shrink factor.

Normally, the mould maker have to calculate all expanded dimensions in prior to the machining. With the ES-8A's shrinkage compensation function which actually expands the actual dimension by shrink factor, it enables the operator to drill directly according to the dimension specified in the drawing, no need to calculate the expanded dimensions one by one.

## Operation procedure

1. Enter the Shrink Factor into the ES-8A, in this example, the ABS plastic is used of which the shrink factor is 1.005

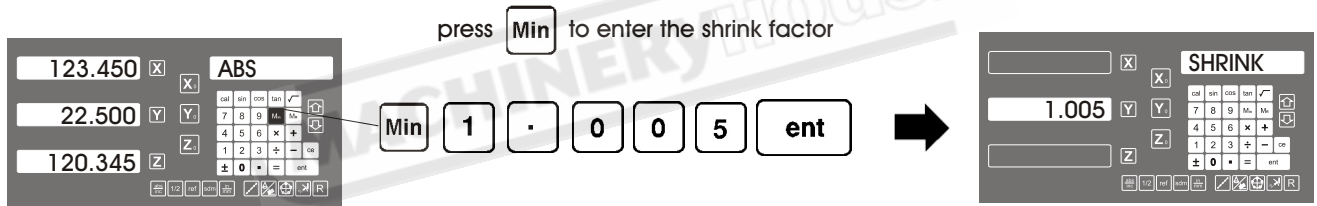

2. Set the ES-8A to Expand Compensation mode for machining

When the DRO is in Shrinkage Compensation display mode, the displayed dimensions in all axes are either "expanded" or "reduced" by the ratio of **shrink factor**.

To remind the operator that the DRO is in Shrinkage Compensation mode, the message display will displaying :

- 1) The message of "+ SHRINK" and keep flashing
- 2) Give a beep sound for every 10 sec.
- 3) All DRO functions are disabled

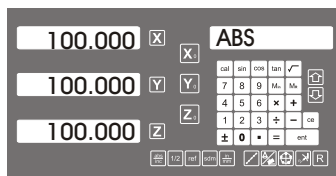

Actual Dimension display

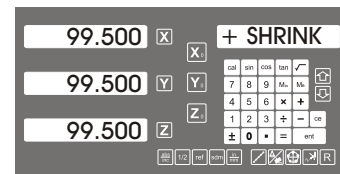
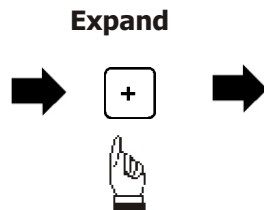

Shrinkage Compensated display

The displayed dimension are now divided by the **shrink factor** ( 1.005 in this example )

## Shrinkage Calculation

During the machining, operator can return the normal dimension to verify if the machining properly calculated or not .

To cancel the shrinkage compensation mode display, press **ce** to return to normal dimension display

currently in **shrinkage compensation** display

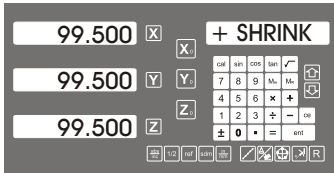

return to normal display

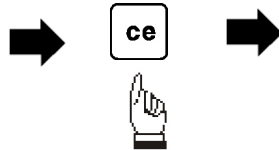

normal actual dimension display

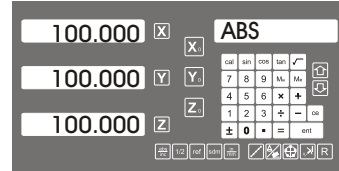

After completed the verification, the operator want to come back to shrink compensation mode display for further machining.

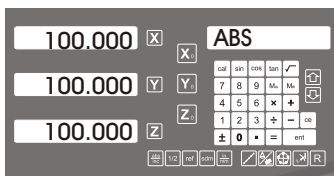

Actual Dimension display

Expand

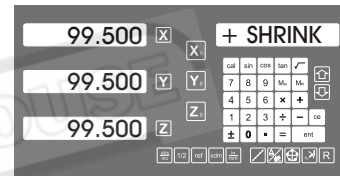
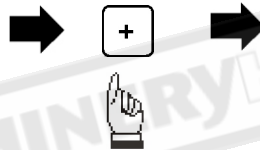

Shrinkage Compensated display

The displayed dimension are now divided by the **shrink factor** ( 1.005 in this example )

# Application supplement for LATHE

This supplementary chapter of the manual is only valid for the setting of **DRO TYPE = LATHE** in the **SETUP** menu.

This is an supplementary chapter to the normal operation manual, it gives more realistic operational examples for the DRO operation for LATHE application.

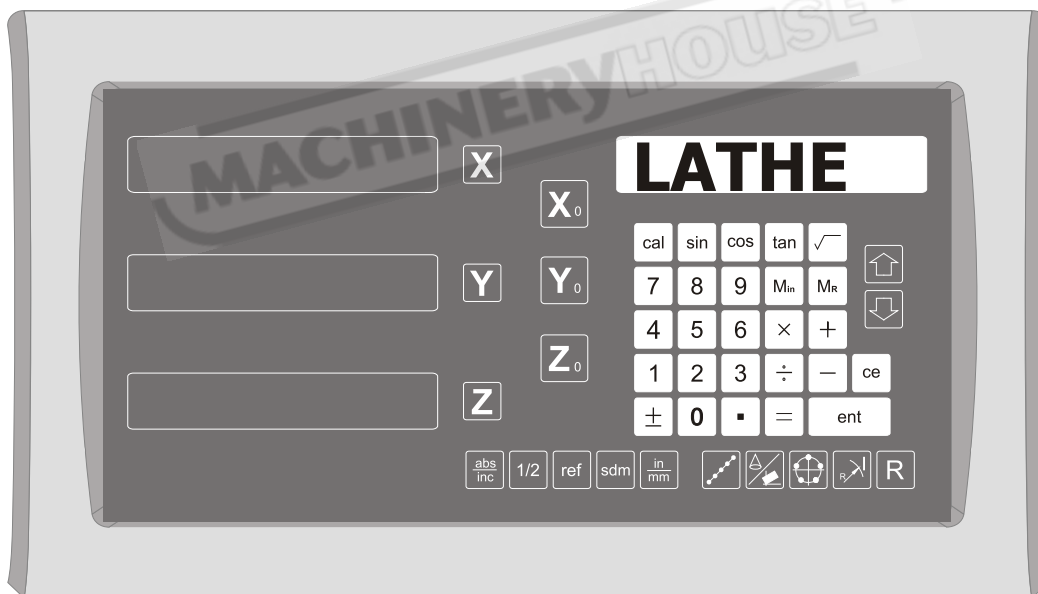

**Function :** Since the structure of Lathe machine and also the machining process in lathe is very different from common vertical or horizontal machines like milling, boring or drilling machines.

The diagram on the Left showing a very typical installation of DRO in lathe and showing the name of the axes.

It is a common practise ( no technical reason, just commonly the people like to do it that way or they used to do it that way ) that :

1. X axis display is installed in the cross axis of the lathe.
2. Y and/or Z axes displays are installed in the longitudinal axis of the lathe. In the case for a two axes DRO, the Y axis is normally used as the longitudinal axis display as per shown in the diagram.

It is very common that two scales are installed in the longitudinal axis direction of the lathe, let's say Y and Z axes of an 3 axes DRO's display, in such case, operator want to have the summing of these two axes when during the machining, but when during the setup of the work piece datum, he will naturally prefer to have these two axes in their own position display separately.

The difficult mission for us when we design the summing function of this DRO is different people have different practise, some of them want to put the longitudinal axis in the X axis display display, but some of them even want to put two scales in the cross axis, especially for the application in a big lathe !! So it makes the axes display have to be summed very confused.

At the end, this DRO provides a flexible temporarily summing display for both the YZ or XZ axes display, so that the operator can choose the axes they want to have summing display.

For the INCL function, because of the machine structure, and the installation of scales is not very defined, therefore, it is useless to offer INCL function in XZ or YZ plane because the lathe machining process only a 2D process. Therefore INCL function in the XY plane is enough for the lathe application.

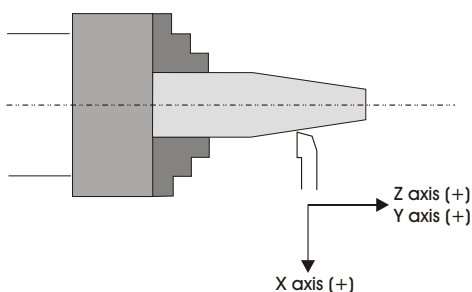
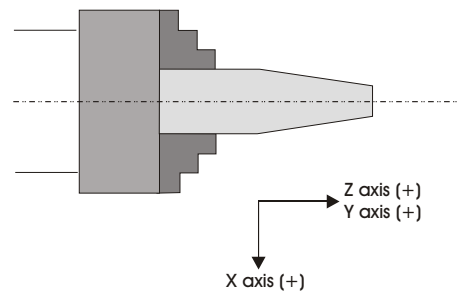

Also, the Y axis should be the main axis in the INCL function in Lathe.

Therefore, please notice that the INCL plane in Lathe has following difference compared to other application.

- 1) **No need to select INCL plane, the DRO assumes all INCL operation in XY plane only.**
- 2) **The Y axis is the main axis during the INCL machining mode, the X axis zero position display will be presetted by the DRO along an inclined angle wherever Y axis is posited.**

## Basic Functions - Dimension Preset

**Purpose :** Set the current position for that axis to an entered dimension

**Example :** To set the current X axis position to be 45.800mm

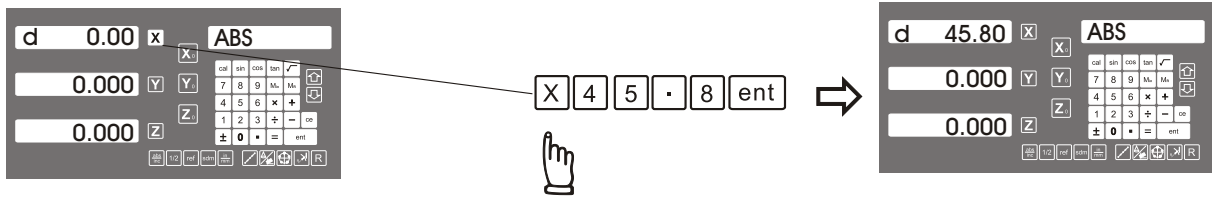

**Application tips for lathe :** The dimension preset function provides a very convenient way to monitor your cross feed in lathe machining. Let's assume the DRO's X axis is installed as per the diagram below.

- a) Set the X axis display to be the DIA display in the SETUP mode
- b) Make a slight first cut at the work piece along the Z axis, after finish this first cut, move the tool away from the work piece along the Z axis, it is important that don't move the X axis at all in order to keep the X axis position right at the cutting position of making this first slight cut.

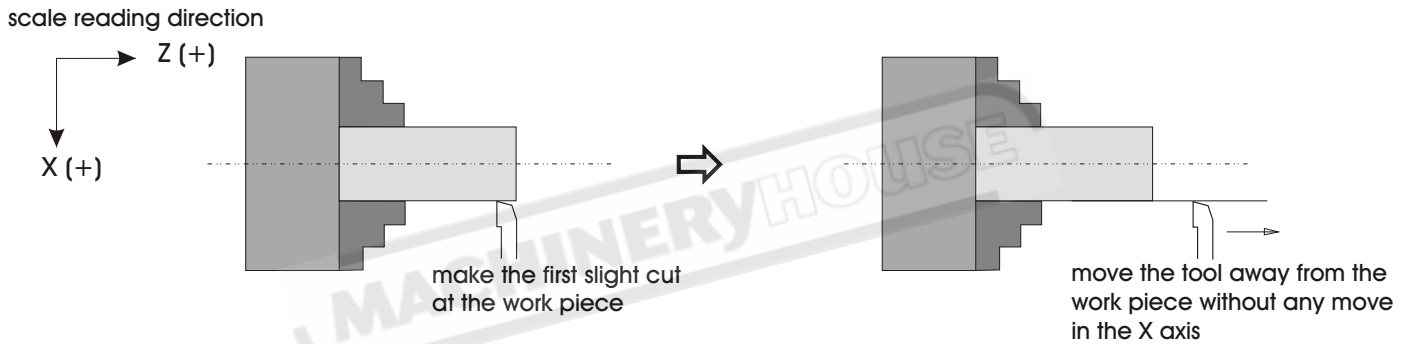

- c) Measure the work piece by a caliper. ( i.e, The measured diameter of the work piece is 45.80mm )

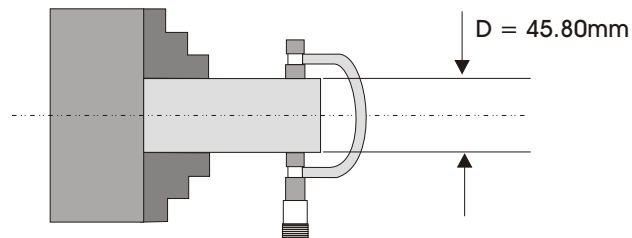

- d) Enter this measured diameter into the DRO by dimension preset function.

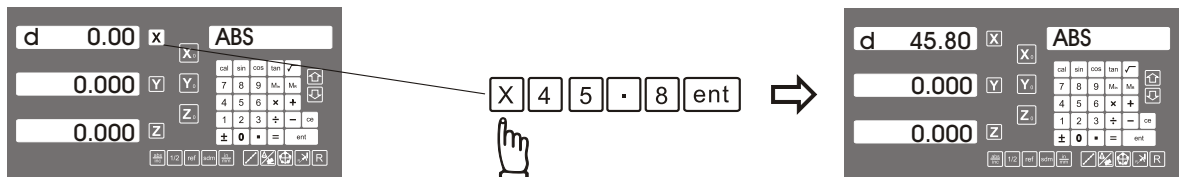

- e) Since the X axis tool position is now at the position of making the first slight cut, and it is the measured diametral reading of the work piece, if we preset this dimension into the DRO, then from now on, whatever dimension shown on the X axis display, it is the actual diametral dimension of the work piece.

## Basic Functions - 199 tools datum memory

**Purpose :** This DRO offer 199 tools memory, it is offered as a supplement of ABS/INC coordinates. For the lathe that have a high repeatability tool turret, this function provides a very quick way to memory the tool tips offset, so that the operator don't have to datum the tool tips position whenever tool change is made.

**Example 1 :** Currently in INC display coordinate, to switch to TOOL 1 display coordinate

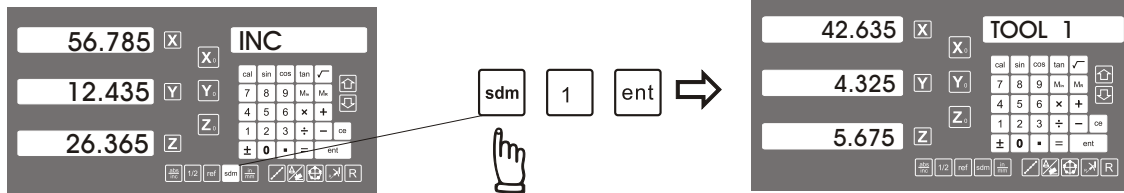

**Example 2 :** Currently in TOOL 3 display coordinate, to switch to TOOL 9 display coordinate

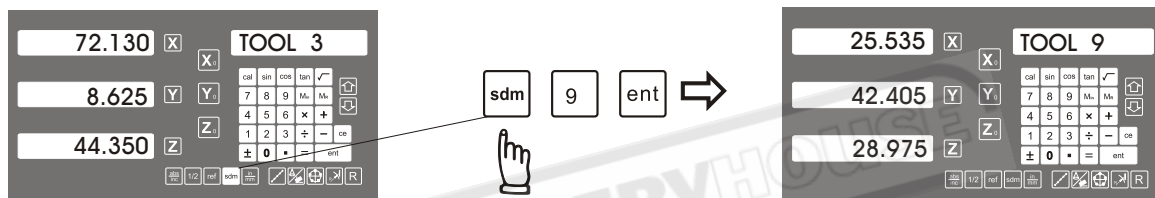



## INCL function - To swing the tool turret on the cross slide for conical machining

To machine a conical work piece as per the diagram shown, it is the most basic that we have to swing the cross slide of the tool turret accurately at the incline angle that we have to machine.

Most of the tool turret on the lathe have an angular dial allow the operator to swing the tool turret to the angle that required. However, this angular dial is usually very coarse and not accurate enough.

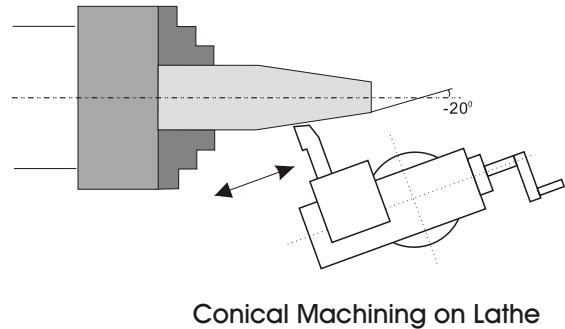
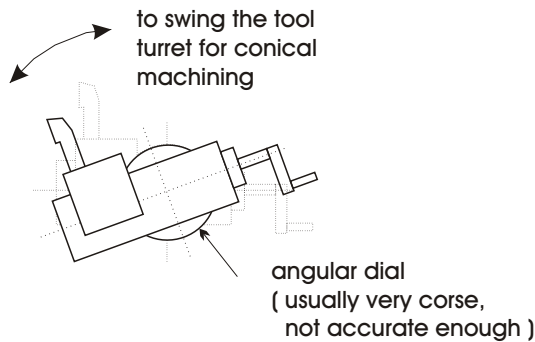

**Example :** To accurately swing the tool turret on the cross slide by -20 degree, so that the operator can make to conical machining as per following diagram shown.

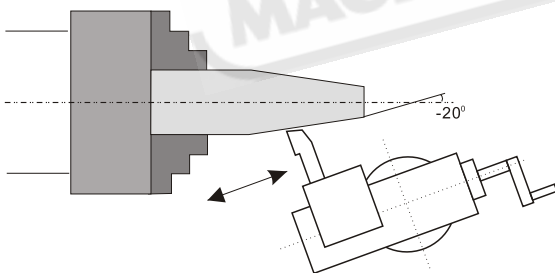

### Directional Notations

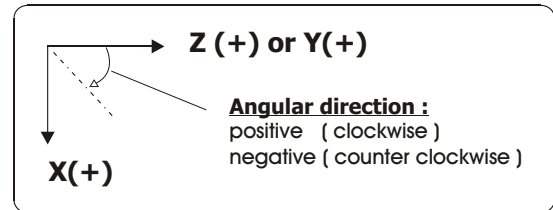

**Step 1 :** Swing the tool turret to 20 degree according to the angular dial of the tool turret, swing it to the angle of 20 degree as accurate as possible, remove the cutting tool and put a dial indicator onto the tool turret, install a bar on the lathe as shown.

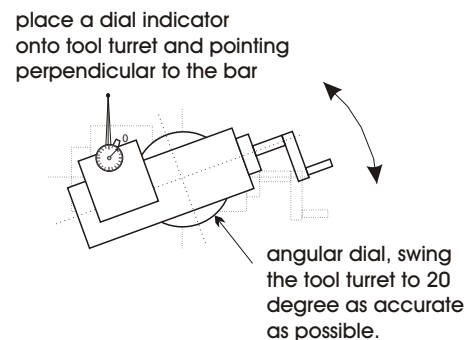
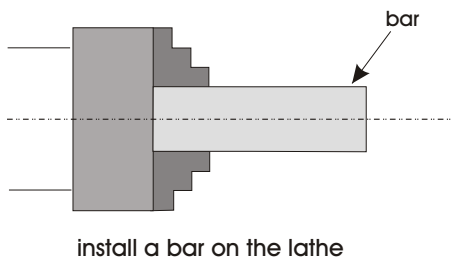

# INCL function - To swing the tool turret on the cross slide for conical machining

**Step 2 :** Enter into the INCL function

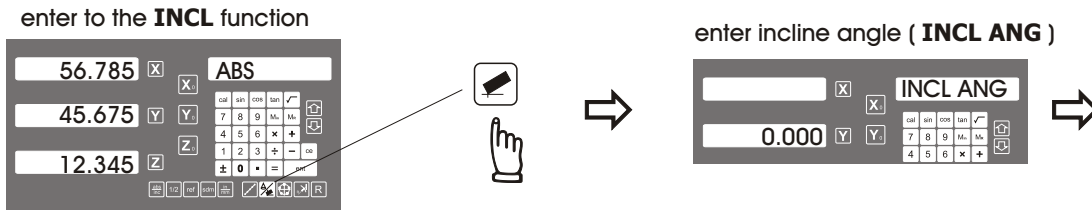

**Step 3 :** enter the incline angle ( **INCL ANG** )

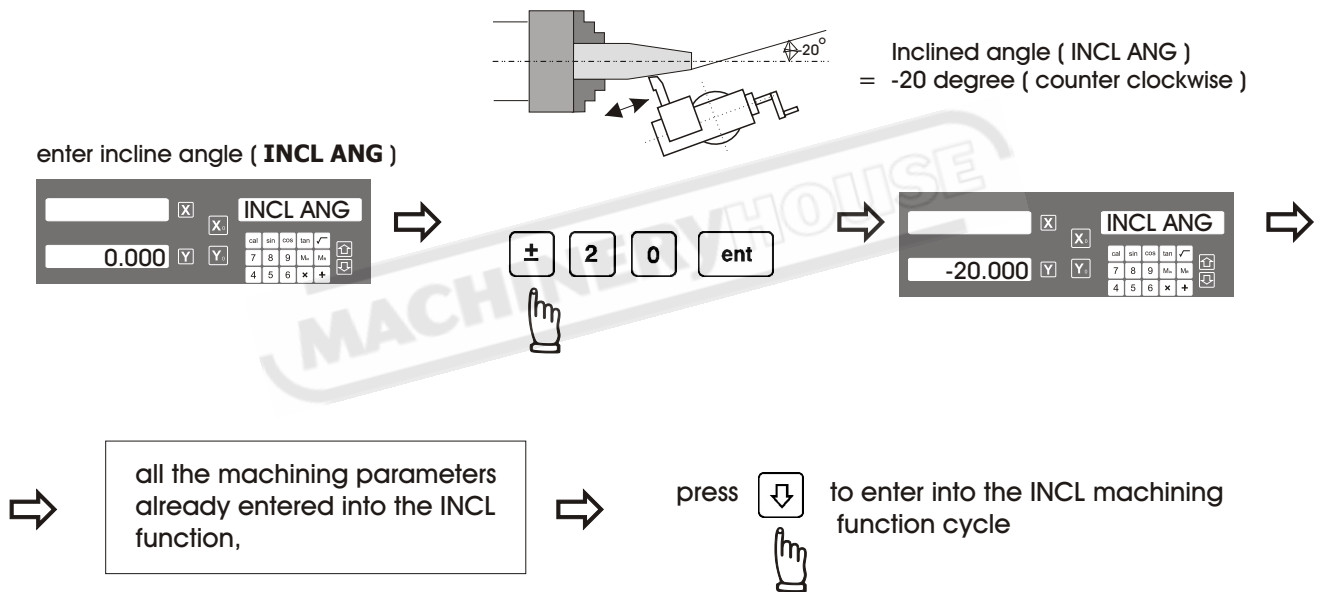

**The DRO is now entered into the INCL machining function cycle**

The swinging of the lathe's tool turret on the cross slide to an inclined angle of 20 degrees accurately is an iterative process, operator have to repeat the steps ( Step 4 to Step 8 ) below until he thinks he already achieved the accuracy required, operation are as follows.

**INCL function - To swing the tool turret on the cross slide for conical machining**

**Step 4 :** place the dial indicator against the bar, and ZERO both the DROs and the dial indicator

zero the Y axis to redatum the Y axis

**XY plane INCL machining mode display**

0.000	X	ANG -20.0
0.000	Y	
		7 8 9 M L M
		4 5 6 X +

X display is shifted left to remind the operator that the axis display zero position is preset to =  $Y * \tan(\text{ANG})$  operator simply move the machine to X = 0.000, then the tool is accurately located at the inclined axis.

posit the dial at the work piece ( bar ),

- 1) ZERO the dial indicator
- 2) ZERO both X & Y axis by pressing **Y<sub>0</sub>**

**Step 5 :** move the tool turret to a distance ( let's take an example of 50mm ) as per shown in following digram, calculate the Y axis ( Z axis ) travel by the COS ( angle ) of the moved distance along the tool turret

dial reading which enables the operator move the tool turret for 50mm accurately.

**Y axis ( Z axis ) movement**  
 $50 \times \cos(20) = 46.985\text{mm}$

move the tool turret by 50mm ( move according to the dial in the turret )

**Step 6 :** move the cross slide ( Y axis or Z axis ) to the COS distance of the tool turret movement as per diagram shown in below , ( in this example =  $50 \times \cos(20) = 46.985\text{mm}$  )

move the cross slide along Y axis ( Z axis ) by  $50 \times \cos(20) = 46.985\text{mm}$

17.100	X	ANG -20.0
49.985	Y	
		7 8 9 M L M
		4 5 6 X +

## INCL function - To swing the tool turret on the cross slide for conical machining

**Step 7 :** Move the lathe's cross slide along X axis until the X axis DRO display = 0.000

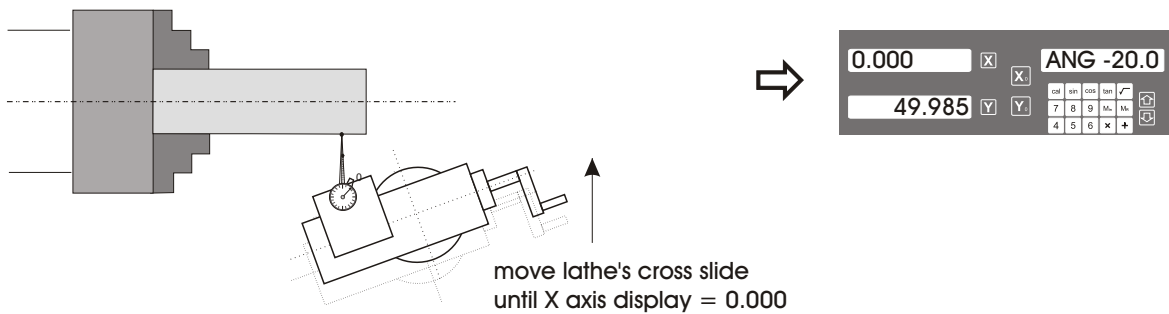

**Step 8 :** Swing the tool turret until the dial indicator pointing to ZERO

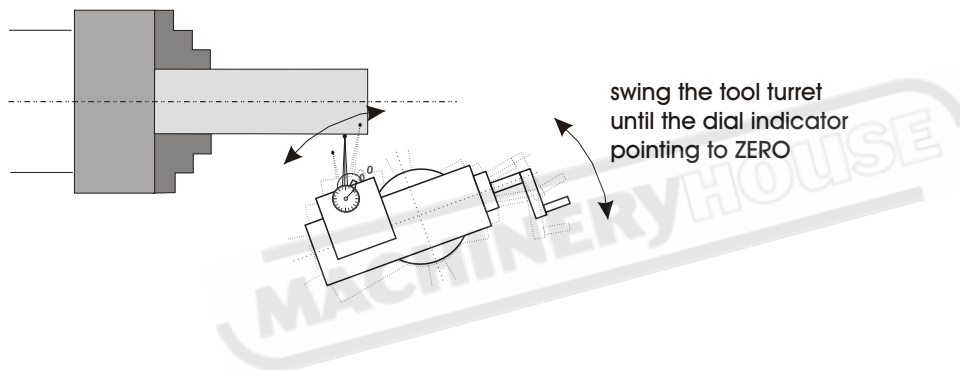

The angular alignment of the tool turret is an iterative process, operator may have to repeat the Step 4 to Step 8 again to fine tune the incline angle, until there is no swinging of the tool turret is needed in the Step 8, which means the best possible alignment accuracy has been achieved.

**Step 9 :** The tool turret have been aligned to the inclined angle of 20 degree accurately, press  to exit the INCL function cycle, put off the dial indicator and replace with lathe cutter tool for conical machining.

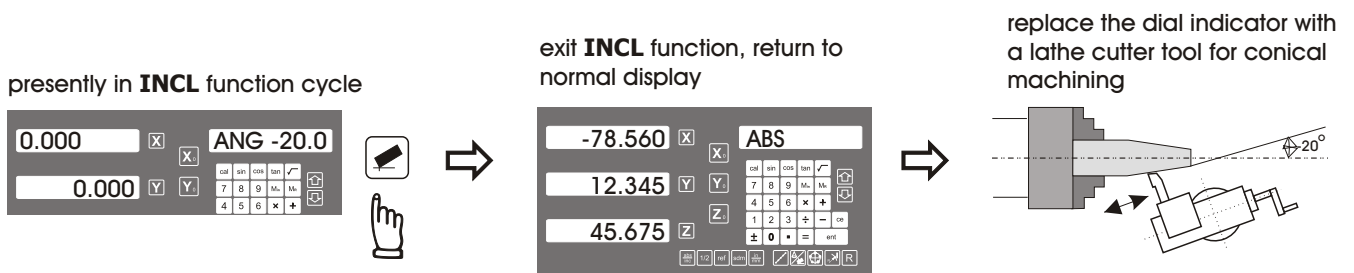

## INCL function - cone measurement

**Example :** The INCL function of this DRO can be used in making the measurement of a conical work piece as per the diagram shown.

Normally, the tool turret of the cross slide of the lathe can be swing to a inclined angle for conical machining, the angular alignment of the tool turret have been demonstrated in the other chapter of this manual.

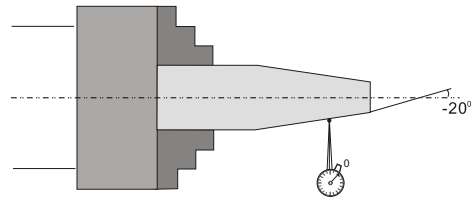

**Cone measurement**

After the conical measurement, we can also use the INCL function to make measurement on the machined work piece. This DRO offers cone measurement function for the ease of cone angle measurement to help the operator to obtain an accurate and faster conical process.

For example, to verify the conical work piece that have been machined at an inclined angle of 20 degree on the XZ plane as shown in the following diagram.

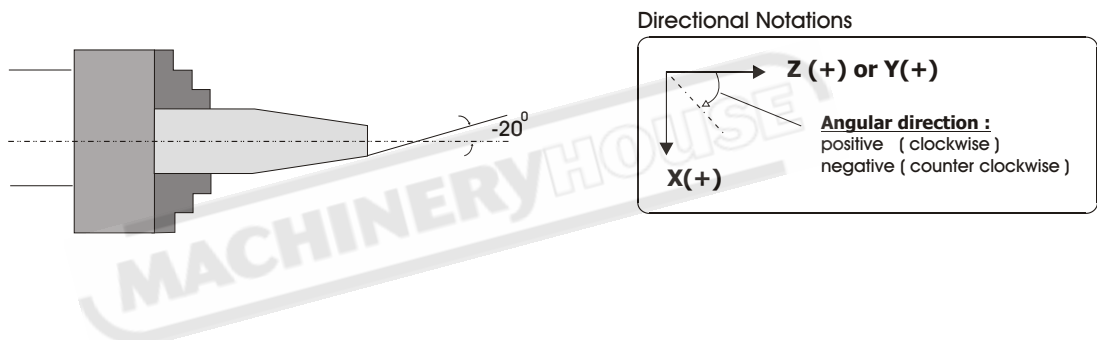

**Step 1 :** Place the dial indicator against the conical work piece as per following diagram shown, and ZERO the dial indicator

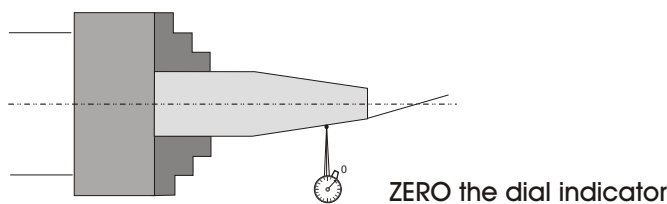

**Step 2 :** Enter into the INCL function

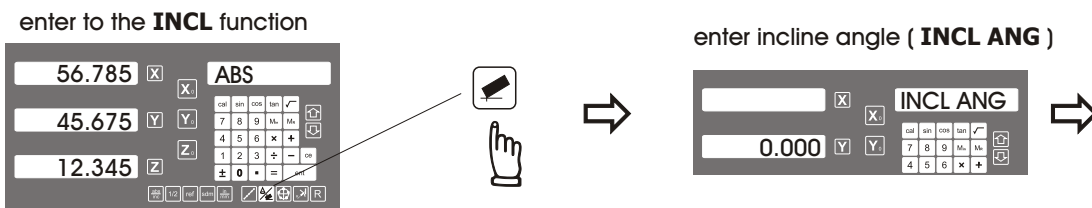

## INCL function - cone measurement

**Step 3 :** enter the incline angle ( **INCL ANG** )

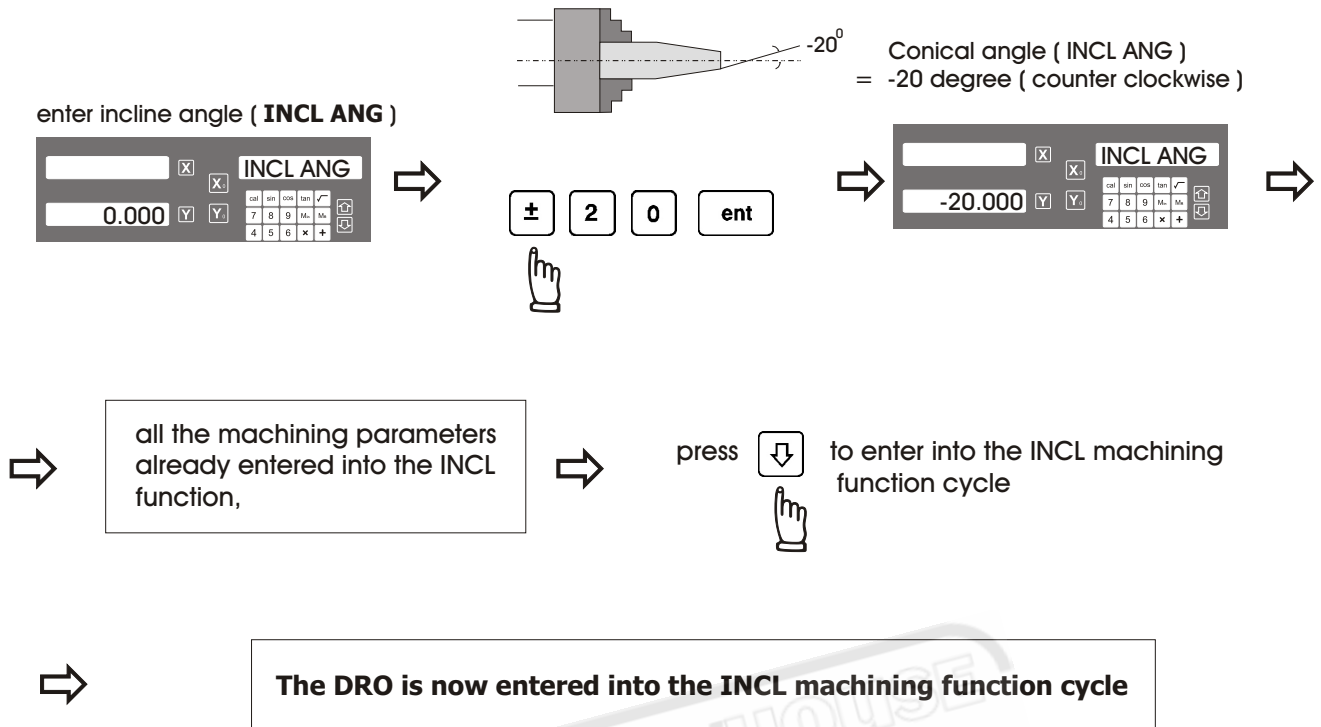

**Step 4 :** ZERO the dial indicator at one end of the work piece, and also ZERO the DRO by pressing

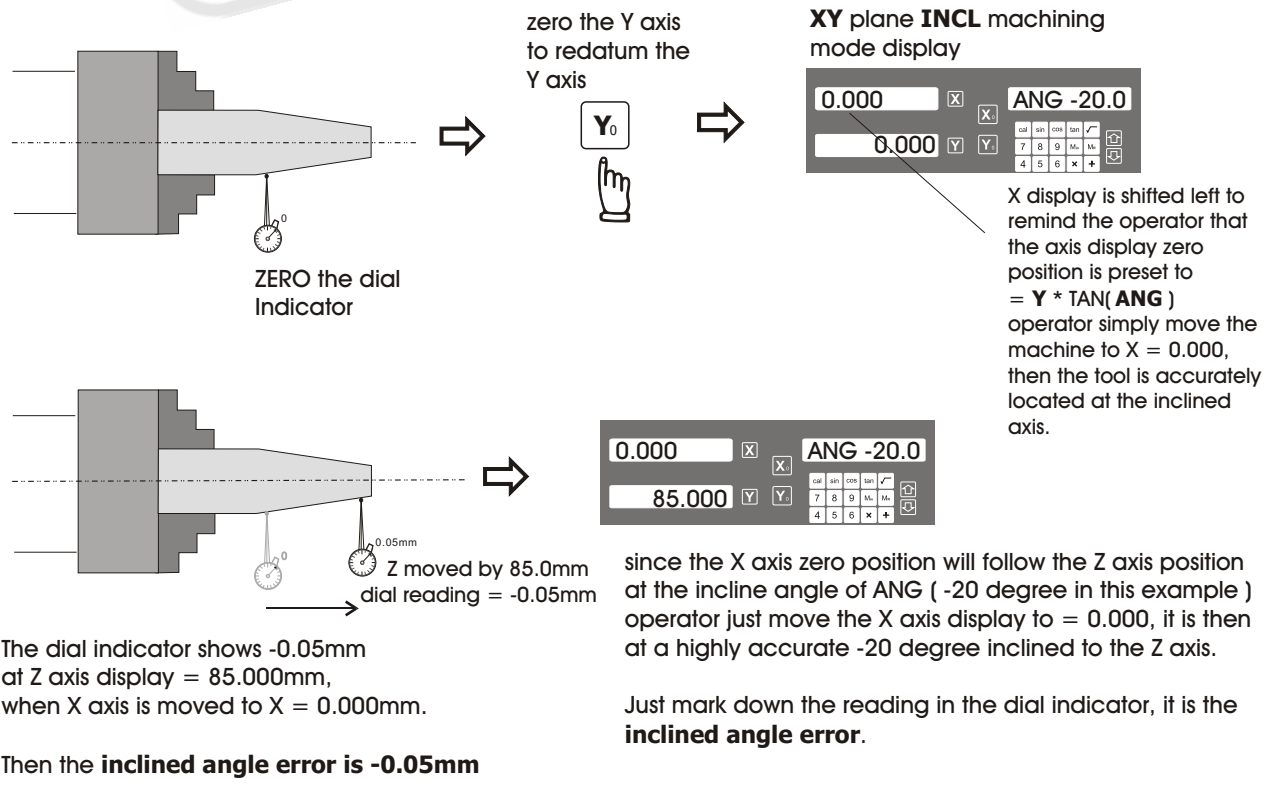

## INCL function - cone measurement

Anytime the operator want to check or verify if the DRO's INCL calculation correct or not, or want to temporarily exit the INCL machining mode display ( swap back to normal XYZ display ), procedure are as follows :

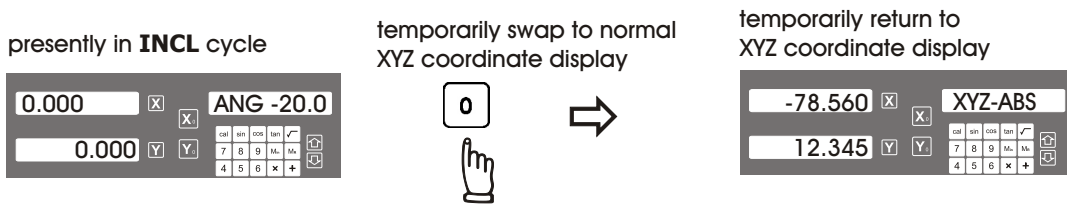

swap back to **INCL** machining mode display continue the cone measurement operation

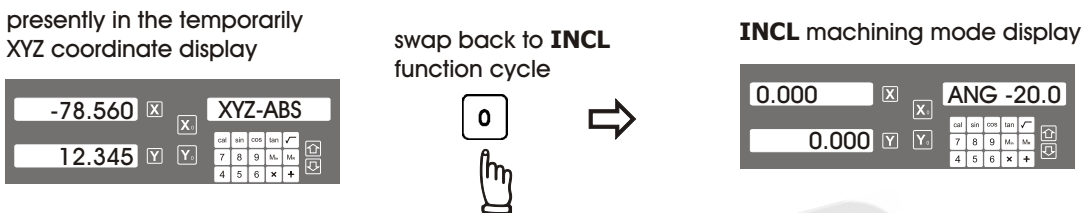

After the **INCL** machining operation completed, press  to exit from the INCL function cycle.

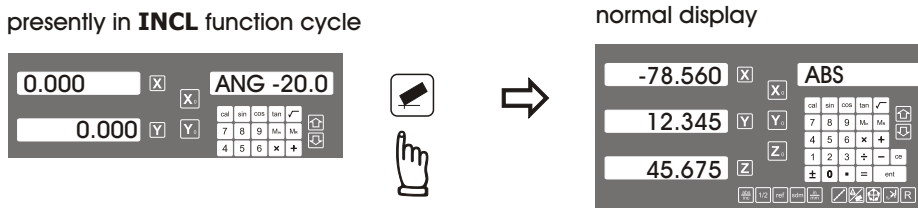

## Diameteral / Radius Display swap function ( In Lathe operation mode only )

**Purpose :** Switches between Diameteral and Radius ( true dimension) display for X axis

In case the DRO is set in lathe operation mode, the X axis can be set to Diameteral ( X2 true dimension ) or Radius ( true dimension ) display by simply press the **[R]** function button.

The mode of display will be store into the memory of the DRO. It will restore the current mode of display even the DRO have been switched off.

**Example 1 :** Currently in Radius display, to swap to Diameteral display

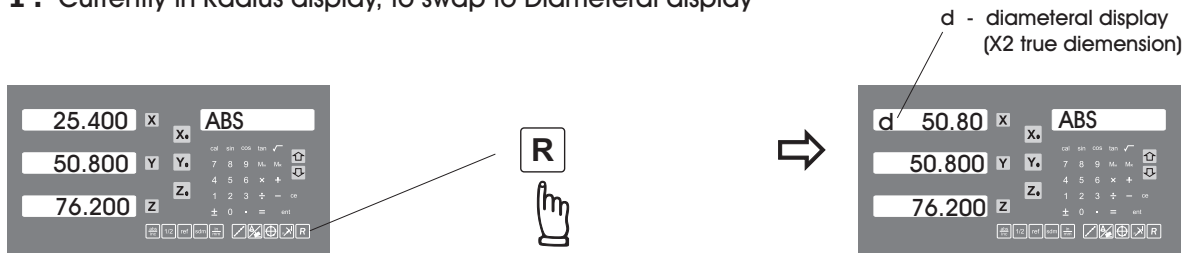

**Example 2 :** Currently in Diameteral display, to swap to Radius display

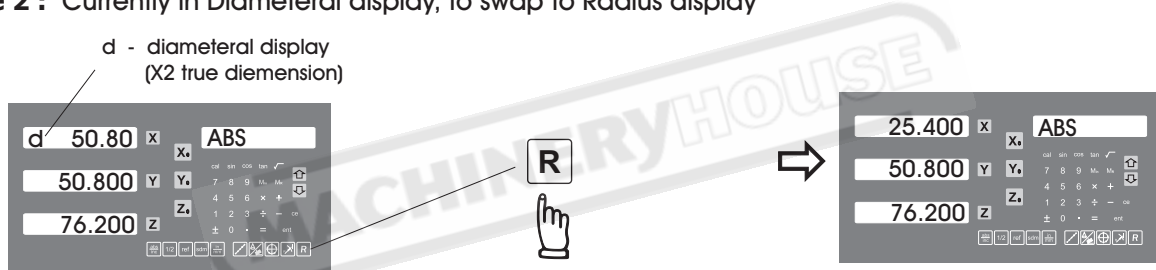



---

# Parameter Setup

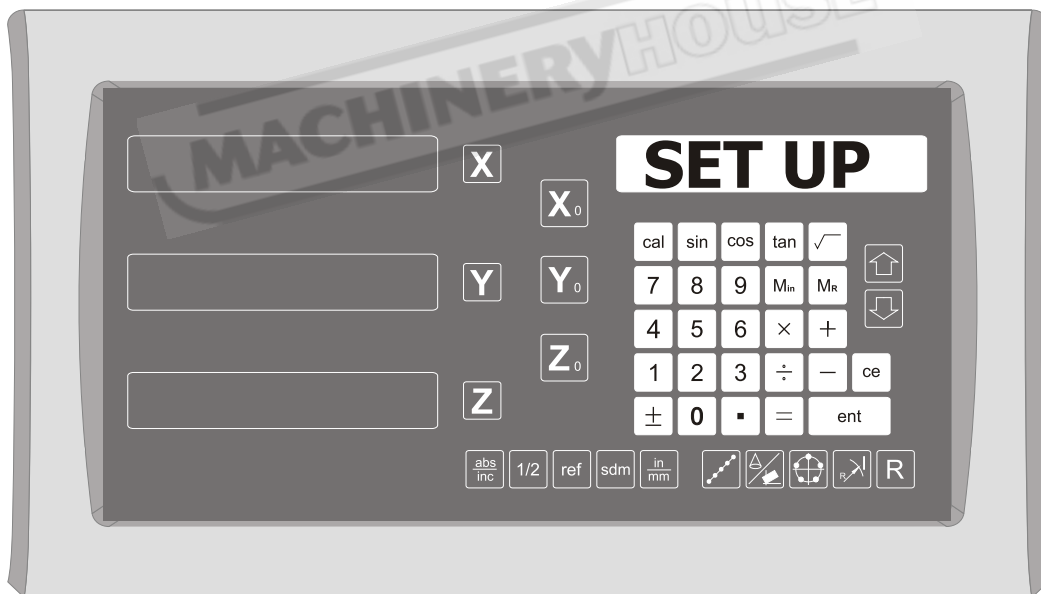

# Parameters Setup Procedure - System Reset

## A) Parameters Reset

Each ES-8A is configured as it leaves the factory, however, all parameters memory are backup by the internal rechargeable battery which can only last for 30 days after switched off. Therefore, if the DRO have been powered off for more than 30 days, the ES-8A parameters might have to be reset or reconfigured. Followings are the reset procedure for the ES-8A.

### Operating Procedure :

- 1) Switch off the ES-8A
- 2) Switch on the ES-8A, after switching on, with the software version no " VER. X-? " showing in the message window, press the number "8" key to enter the parameter reset function.

DRO proceeds a self test on electronics circuit after switched on

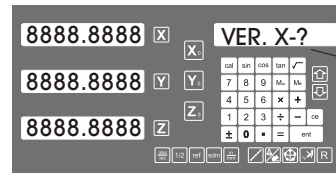

software version

with the software number displayed on the message window, for example, "VER. M-3"

press **8** to enter into the reset function

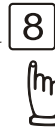
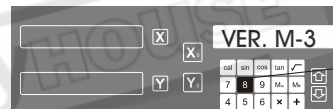

- 3) After entered in the reset function, ES-8A will process a "RAM TEST" to test all RAM memory, and also reset all RAM memory to 0. Finally, resume all factory default setting.

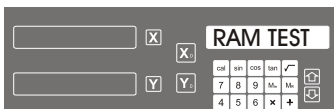

DRO displays "RAM TEST" means RAM test is in progress

DRO displays "RAM OK" means RAM memory tested OK

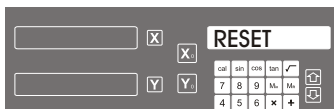

DRO displays "RESET" means all parameters have been resumed to factory default setting

- 4) Reset completed, the ES-8A will proceed LED display test until switch off.

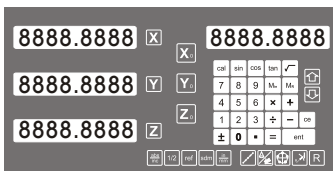

Reset completed and ES-8A enters into a endless LED test to let user know if there is any missing segment in the LEDs, you can switch off the DRO if you found no missing segment in the display LEDs

---

## Parameters Setup Procedure - Introduction

---

### B) Parameters Setup

Each ES-8A is configured as it leaves the factory, however, in order to enable each ES-8A to be individually set up for particular machine and application, following SETUP procedure is used.

The SETUP procedure is written in a menu mode which enable you to using the pressing "UP" or "DOWN" keys to scroll through the top level selection options, simply press "enter" to come into the respective configuration mode, configure your choices and then exit the sub-functions as they arise.

**The top level menu headers in orders are as follows :**

<b>DRO TYPE</b>	The ES-8A is capable to provide professional ES-8A functions for following applications, 1) MILL - Milling machine application 2) LATHE - Lathe machine application 3) GRIND - Grinding machine application 4) EDM - EDM machine application 5) CS LATHE - Constant Speed Lathe application
<b>LANGUAGE</b>	To make the ES-8A more user friendly, the display message can be configured to one of the following languages. 1) ENGLISH 2) GERMAN 3) ITALIAN 2) PORTUGUE 4) FRENCH 5) SPANISH 6) CZECH
<b>AXIS NO</b>	Specifies the number of display axes that the DRO have.
<b>DIRECTN</b>	Specifies the diection of count for each axis.
<b>RESOLU</b>	Specifies the display resolution for each axis.
<b>RAD/DIA</b>	Specifies the axis display in RAD( Radius mode - normal display ) or DIA ( Diameter mode - 2X of the true dimension ), all axes can be indivdually set up in RAD/DIA mode, for those axes that in DIA mode, a "d" character display will be shown at the first display digit of the axis.
<b>LIN COMP</b>	specifies the linear error compensation value ( in PPM ) for each axis..
<b>NL ERROR</b>	Non linear error compensation is available in both X and Y axis of the DRO, this selection permit the non-linear error compensation value to be input. for details operation procedure, please refer to the "Non Linear Error Compensation" chapter.

---

## Parameters Setup Procedure - Introduction

---

### **Z DIAL**

specifies Z axis dial increment of the milling machine.

This parameter is used only for the two axes ES-8A which intent to use the ARC or R function for XZ/YZ plane arc. This parameter allows a two axis DRO to silmulate the Z axis movement for ARC or R machining function.

*For three axes ES-8A, this parameter ( Z DIAL ) is not used, no effectiveness.*

### **DIAL INC**

specifies Z axis movement of the milling machine per Z axis Dial turn.

This parameter is used only for the two axes ES-8A which intent to use the ARC or R function for XZ/YZ plane arc. This parameter allows a two axis DRO to silmulate the Z axis movement for ARC or R machining function.

*For three axes ES-8A, this parameter ( DIAL INC ) is not used, no effectiveness.*

### **R MODE**

specifies the Z axis interopolation method during the ARC or R function.

This ES-8A can offer "MAX CUT" or "Z STEP" for choices.

If "MAX CUT" selected, the ARC or R function calculation will interpolate the ARC in fixed cutting distance for smoothing ARC machining.

If "S STEP" selected, the ARC or R function calculation will interpolate the ARC in fixed Z axis increment for easier and quick ARC machining.

This parameter is used only in two axes ES-8A which allows the two axis ES-8A to simulate the Z axis movement of the ARC machining function.

*For three axes ES-8A, this parameter ( R MODE ) is not used, no effectiveness.*

### **FLTR. PR**

specifies the filtering range of vibration for the vibration filtering function.

This version of software is offering vibration filtering as one of the standard function in this ES-8A.

This function is used primarily for big or very old machine which the machine structure is not very rigid to resist the vibration when during machining or axis movement.

### **QUIT**

exit the SETUP function

## Parameters Setup Procedure - Enter into SETUP

Followings are the control keys that are used in the SETUP function.

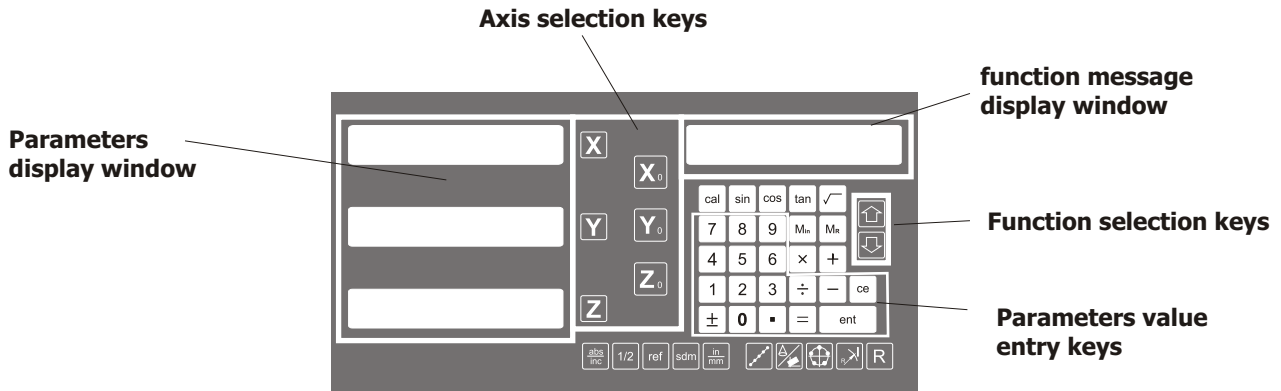



### Operating Procedure of SETUP function :

To enter into the SETUP procedure, after the ES-8A is switching on with software version showing in the MESSAGE window, press the "ent" key to enter into the SETUP function.

1) Switch off the ES-8A.

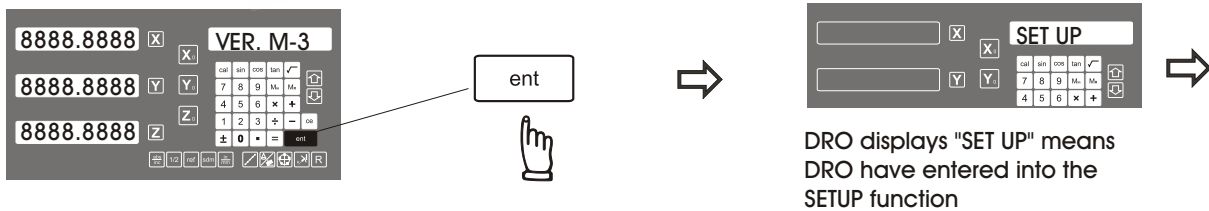
2) Switch on the ES-8A, after switching on with the software version no. "VER. X - ?" in the message window, press "ent" key to enter the parameter SETUP function.



2) Press  or  key to select next function in the menu, the next function after the SETUP is "DRO TYPE" which specifies the FUNCTION TYPE of the ES-8A.

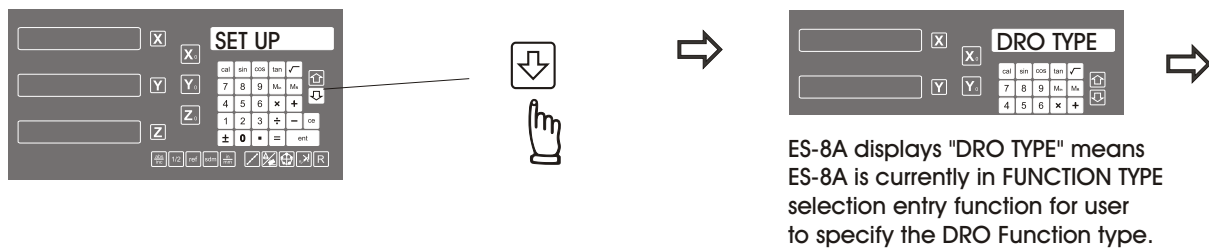

## Parameters Setup Procedure - DRO TYPE

The ES-8A's software is all-in-one software which can config the ES-8A to provide professional DRO functions for one of the following applications, the table below listing out all the DRO functions available for different DRO TYPES.

Press **ent** to select the "DRO TYPE" selection menu

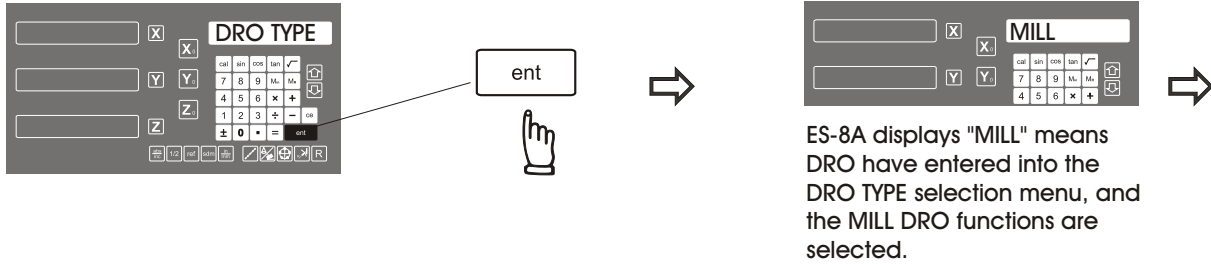

select the DRO TYPE functions

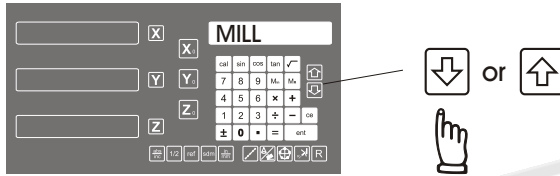

Select MILL DRO functions



Select LATHE DRO functions



Select GRIND DRO functions



Select EDM DRO functions



Select CS LATHE DRO functions



selection done, go to next menu

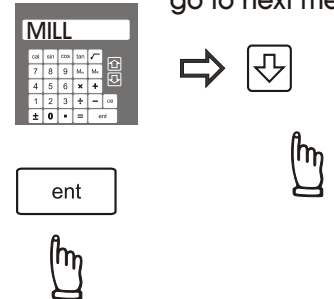

DRO TYPE		mill	lathe	grinder	EDM	CS LATHE
Functions						
Basic functions	- Clear zero					
	- Centering ( 1/2 )					
	- in/mm display					
	- Coordinate entry					
	- abs/inc					
	- power off memory	•	•	•	•	•
	- 199 subdatum					
	- ref memory					
	- 0.005 / 0.001mm					
	- RAD / DIA display					
- speed display						
Built in Calculator		•	•	•	•	•
PCD pitch circle diameter		•			•	
LHOLE line hole positioning		•			•	
INCL inclined machining		•	•		•	•
SHRINK shrinkage calculation		•				
R function	ARC positioning	•				
	simple R	•				
Linear error compensation		•	•	•	•	•
Non Linear error compensation		•	•	•	•	•
Vibration filtering		•	•	•	•	•
Axes summation			•			•
EDM Z axis Relay Output					•	
Spindle Speed Control Output						•

• function available in this DRO TYPE

## Parameters Setup Procedure - LANGUAGE

To make the ES-8A more user friendly to the operator in different countries in the world, the message display of this DRO can be configured to display messages in one of the following languages.

Press **ent** to select the "LANGUAGE" selection menu

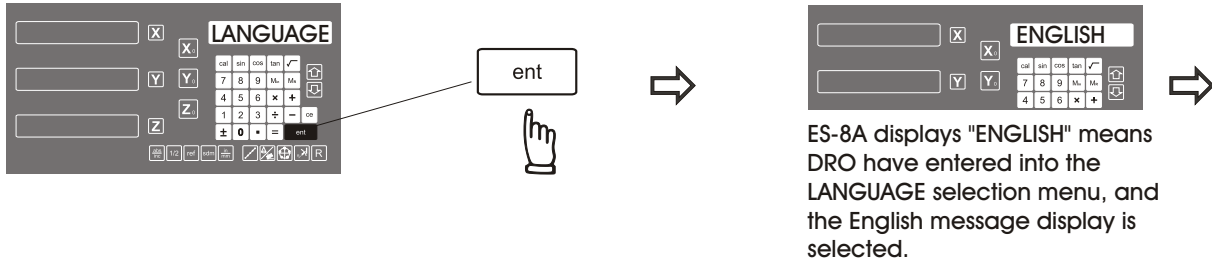

Select ENGLISH message display



Select GERMAN message display



Select ITALIAN message display



Select PORTUGUE message display



Select FRENCH message display



Select SPANISH message display



Select CZECH message display



**select the LANGUAGE displays**

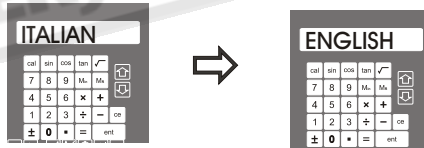
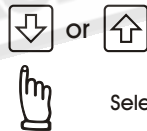
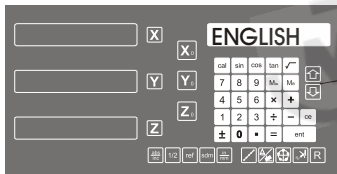

selection done,  
go to next menu

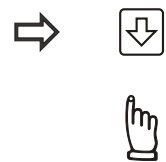

## Parameters Setup Procedure - AXIS NO

AXIS NO menu allows operator user to specify how many axes are existing in the ES-8A. Operator can simply enter '1'- single axis, '2'- two axes, '3'-three axes or '4'-four axes. This parameter will affect the operations of all axis related functions such as ARC, R, ZX/ZY/UX/UY axes summation and INCL. If the operator do not specify the number of axes in the DRO correctly, he will find that the ES-8A's display axes are either the axis is not count ( display ) at all or the DRO functions not work properly.

Press **ent** to select the "AXIS NO" selection menu

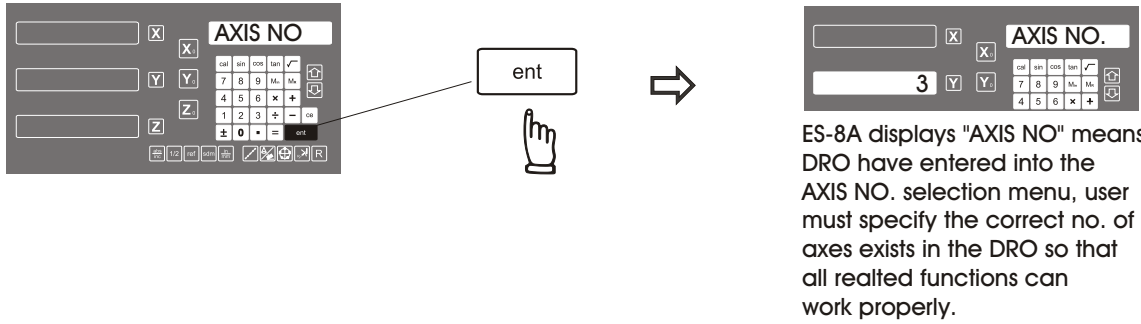

specify the No. of AXES

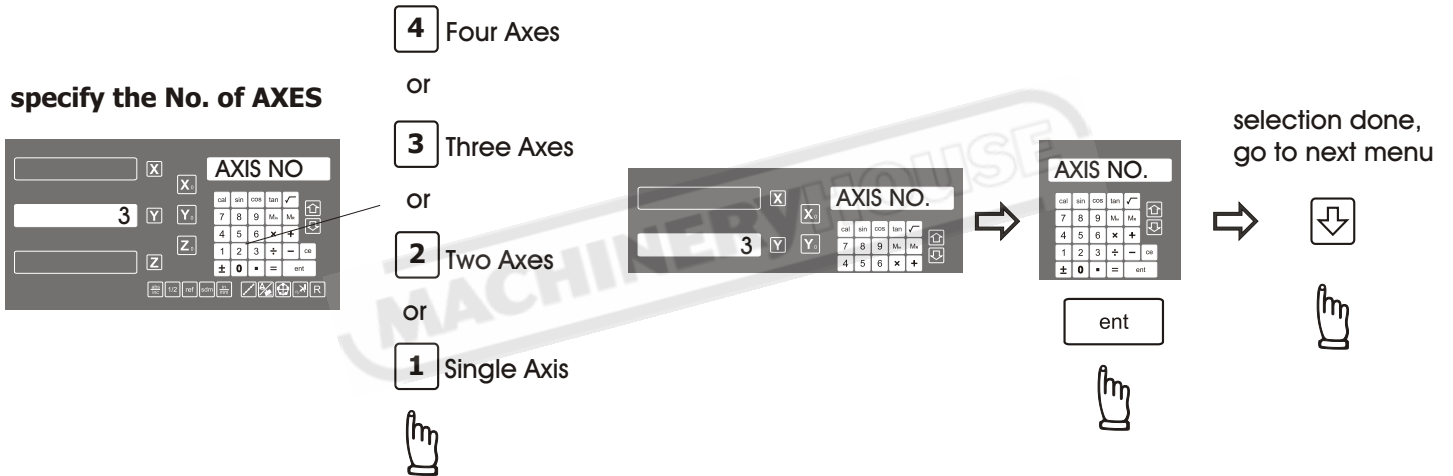



## Parameters Setup Procedure - DIRECTN

DIRECTN menu is designed to allow user to swap the transducer ( linear scale or encoder ) counting direction.

The count direction of the transducer are specified by '0' or '1' :

- '0' - DRO perform normal direct counting of the transducer. ( POSITIVE )
- '1' - DRO will reverse the natural counting of the transducer. ( NEGATIVE )

Press **ent** to select the "DIRECTN" selection menu

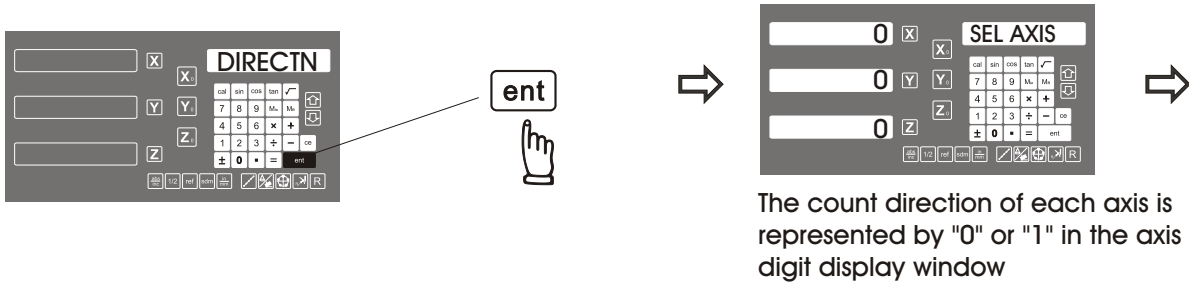

The '0' represents positive counting, '1' represents negative counting. Press the "ent" key to make your selection

For example, if you want to make a change to the current counting direction of X axis, procedure are as follows

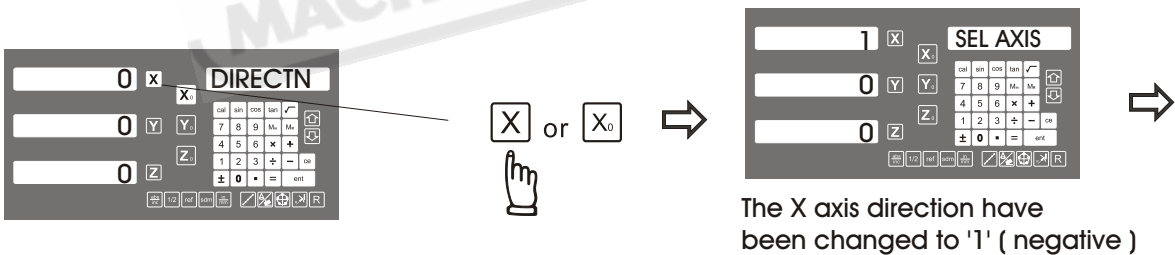

Press **X** or **X<sub>0</sub>** to specify the X axis, if the current count direction is '0', it will swap to '1' after the key press, and vice versa. The same procedure applied to Y , Z and U axis

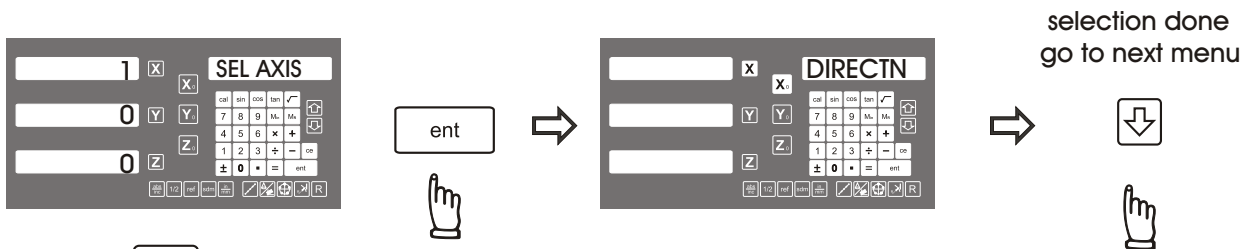

then press **ent** to exist from "DIRECTN" menu and return to the top level menu

## Parameters Setup Procedure - RESOLU

RESOLU menu is designed to allow operator to specify the resolution display for each individual axis. The ES-8A is designed to work with the linear scales of either 0.005mm or 0.001mm resolution. Mixed resolutions display ( i.e. X axis in 0.005mm, Y axis in 0.001mm resolution is allowed in the ES-8A ). All DRO functions can work properly under the mixed resolutions display.

The display resolution is either 0.005mm or 0.001mm, user can simply press the respective axis button to select the resolution display needed.

Press **ent** to select the "RESOLU" selection menu

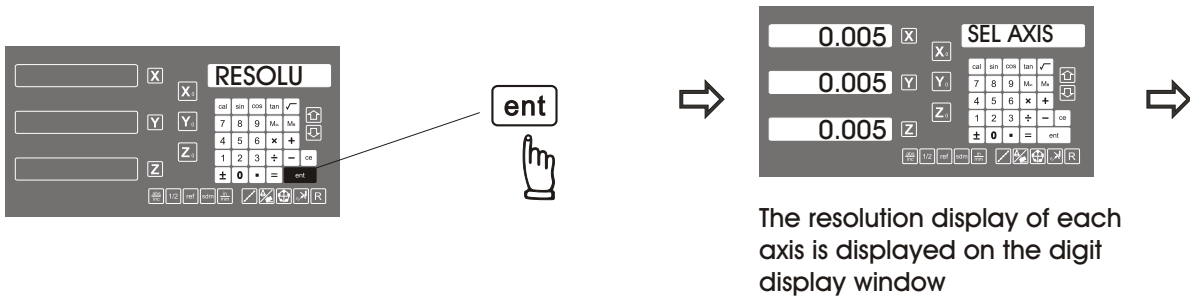

press the axis button to swap the resolution display, make your selection choice by pressing the "ent" key

For example, if you want to make a change to the current resolution ( 0.005mm ) of X axis, to change it to 0.001mm resolution, procedure are as follows

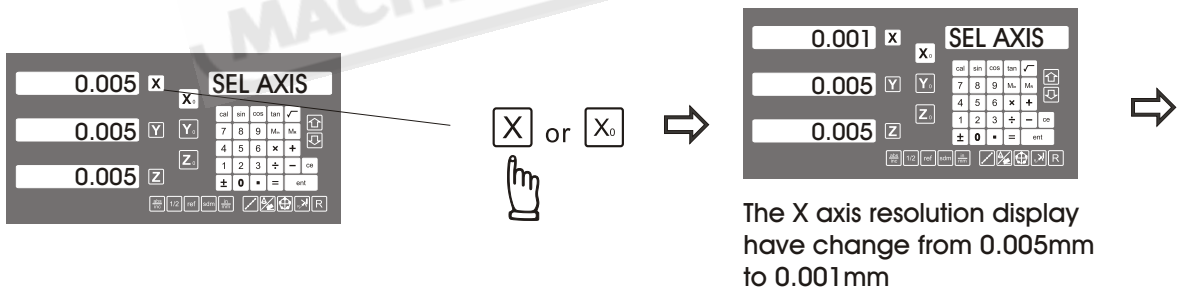

Press **X** or **X<sub>0</sub>** to specify the X axis, if the current resolution display is 0.005mm, it will swap to 0.001mm after the key press, and vice versa. The same procedure applied to Y , Z and U axis

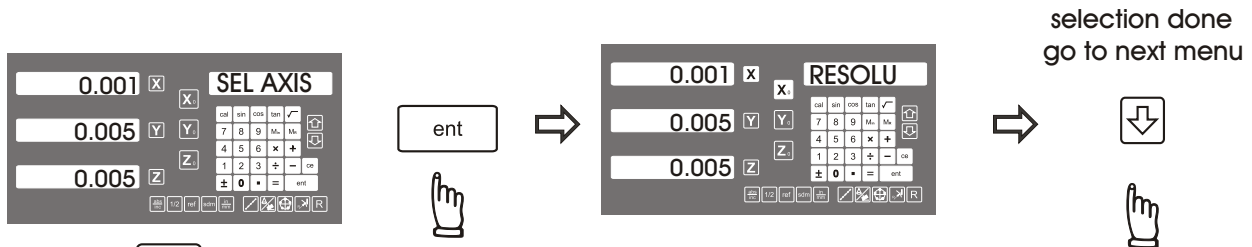

then press **ent** to exist from "RESOLU" menu and return to the top level menu

## Parameters Setup Procedure - RAD/DIA

RAD/DIA menu is designed to allow operator to select the dimension display in Radius ( normal display ) or Diametral ( 2X the real dimension ) display. This feature is very useful for lathe application. All axes in the DRO can be configured to DIA ( 2X ) display. If the axis display is configured as DIA display, a 'd' character will be displayed at the first digit display of the axis to have the user easily recognise the display is in DIA mode. All DRO functions that are normally used in lathe application are tested and confirmed to work properly under the DIA display, such as INCL.

The RAD/DIA of the display axis are specified by 'rAd' or 'dIA' :

'rAd' - Radius mode display selected, axis shows the real dimension reading

'dIA' - Diametral mode display selected, axis shows 2X( 2 times ) the real dimension reading.

Press **ent** to select the "RAD/DIA" selection menu

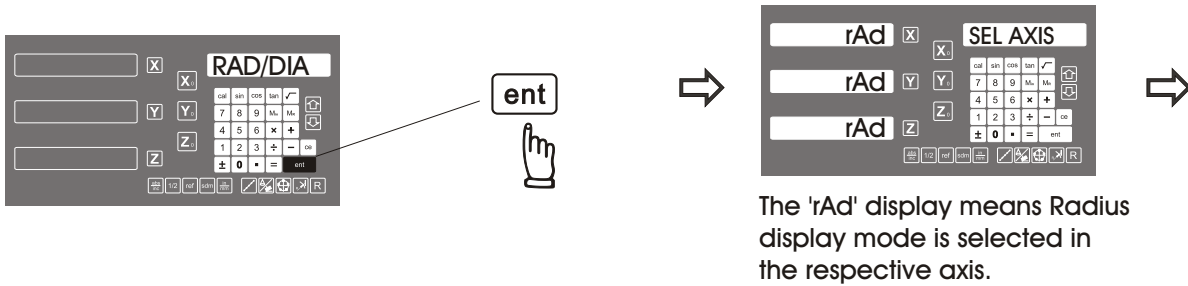

'rAd' represents Radius display mode, 'dIA' represents Diameter display mode. Press the "ent" key to make your selection

For example, if you want to make a change to the current 'rAd' display mode of the X axis, procedure are as follows

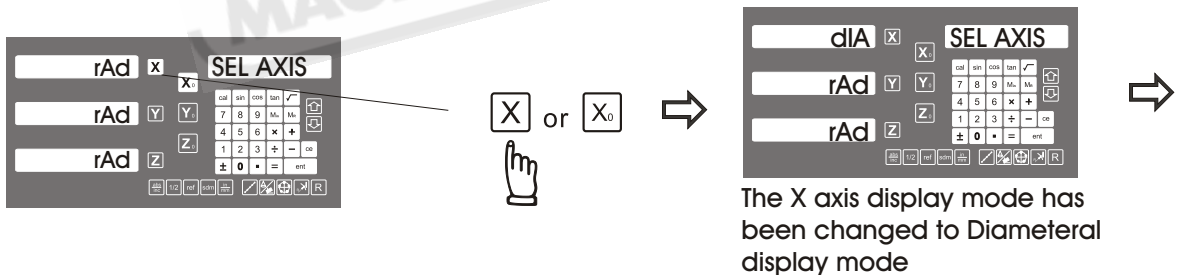

Press **X** or **X<sub>0</sub>** to specify the X axis, if the current display mode is 'rAd', it will swap to 'dIA' after the key press, and vice versa. The same procedure applied to Y , Z and U axis

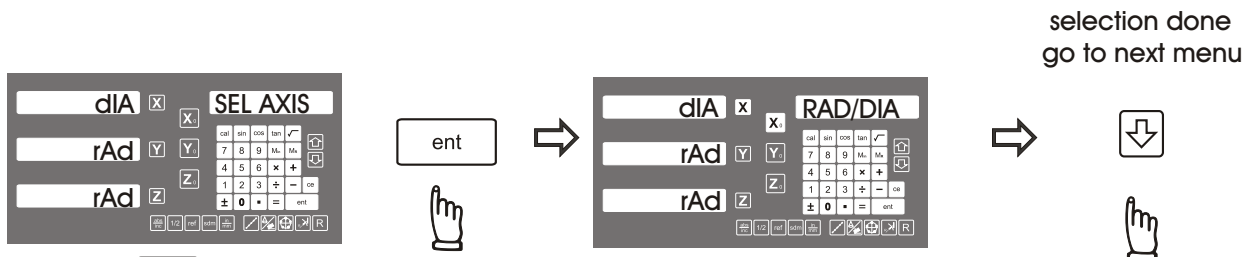

then press **ent** to exist from "RESOLU" menu and return to the top level menu

## Parameters Setup Procedure - LIN COMP

LIN COMP menu is designed to allow user to enter the Linear Compensation value of each axis. The entered value must be in PPM ( Parts Per Million ). If the non-linear error compensation is in active, the Linear Compensation will not be effective any more.

Press **ent** to select the "LIN COMP" selection menu

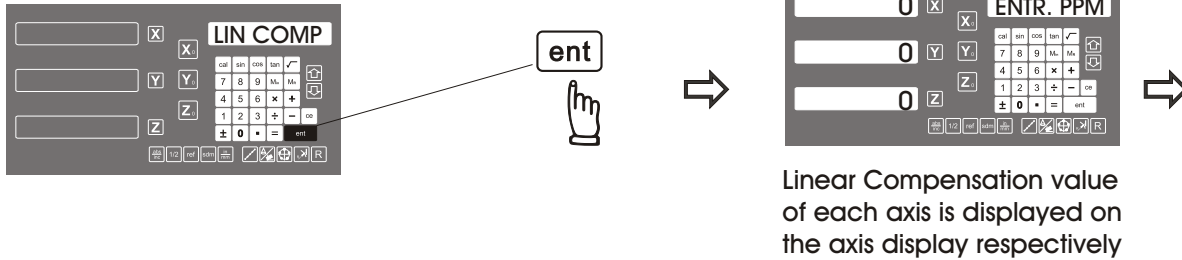

The linear compensation value is specified in PPM [ **P**(arts) **P**(er) **M**(illion) ], an example of calculating the PPM value are as follows.

1. Measure the error using a step gauge or any other device ( e.g. guage block ) of an accuracy level higher than the measuring resolution and the machine as a measuring standard. For example, if you are using an 0.005mm resolution linear scale and the machine is expected to have an accuracy of 0.02mm, the accuracy level of your measuring standard should be ideally at least one grade higher, such as 0.001mm resolution and 0.01mm in accuracy.
2. The error must be recorded in metric unit (  $\mu\text{m}$  - micron - 0.001mm ) ( e.g. we measure the X axis and record a display error of 19 $\mu\text{m}$  shorter over a length of 500mm )
3. Project the error to over the 1 meter ( 1000mm ) in length ( e.g. in the above example, if measurement is 1000mm, the error will be  $19\mu\text{m} \times (1000/500) = 38\mu\text{m}$  )
4. Find the direction of error, if the DRO display longer than the measurement standard, then compensation value should be NEGATIVE, and vice versa. In this example, we find the DRO display is shorter then the standard, therefore compensation value should be an positive value, +38.
5. The PPM value is micron error extrapolated over a meter, the M(illion) referred to in calculation is 1 million microns to the meter. ( e.g. in the above example, the entry compensation value should be +38 )

### Enter the X compensation value

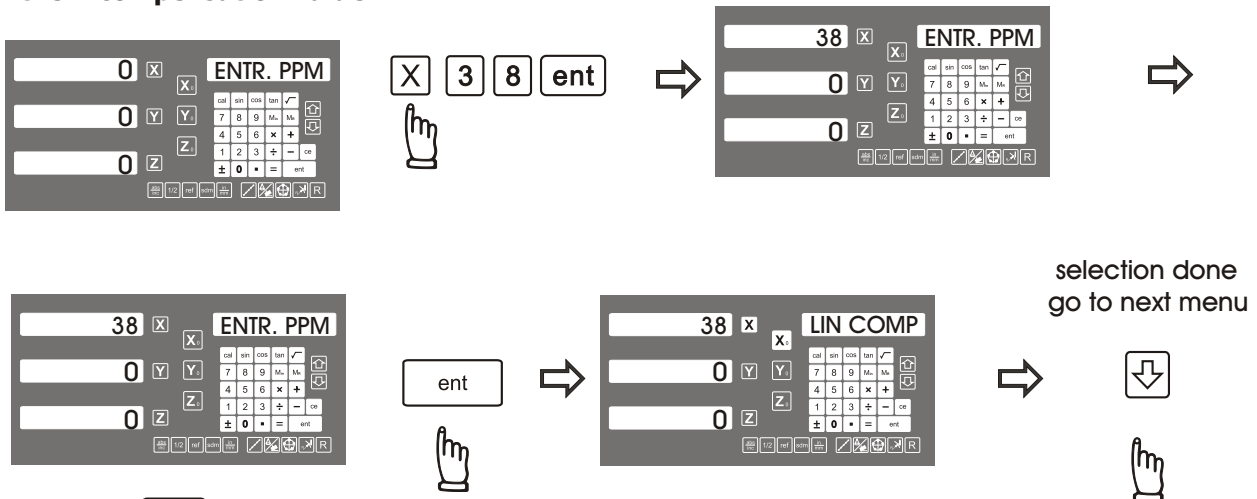

then press **ent** to exist from "LIN COMP" menu and return to the top level menu

## Parameters Setup Procedure - NL ERROR

NL ERROR menu is designed to allow user to enter the Non Linear Error Compensation value into the DRO, so that the DRO can compensate virtually all type of error in the machine. With DRO's non linear error compensation function, as long as the position repeatability of the machine is good, it can greatly improve the machine accuracy. This feature is very useful in the application which demand very high machine accuracy. Such as Grinder application, Borer application and etc..

### Principle of Operation.

Non Linear Error Compensation makes use of the REF ( reference mark ) position of the linear scale to provide a fixed position as absolute zero of the machine. The DRO's CPU then compensates the readout readings according to the error table that built during this SETUP process. The compensation always started at the error curve start position as per the diagram below. It is vital important to have the CP-START position located at the most negative position of the machine, so that most of the machine travel range are covered by the non-linear error compensation. This DRO software offers non-linear error compensation in both X and Y axes, Maximum of 62 compensation steps is possible for each axis. Please notice that, after the non-linear compensation is in active, the linear compensation is not active any more.

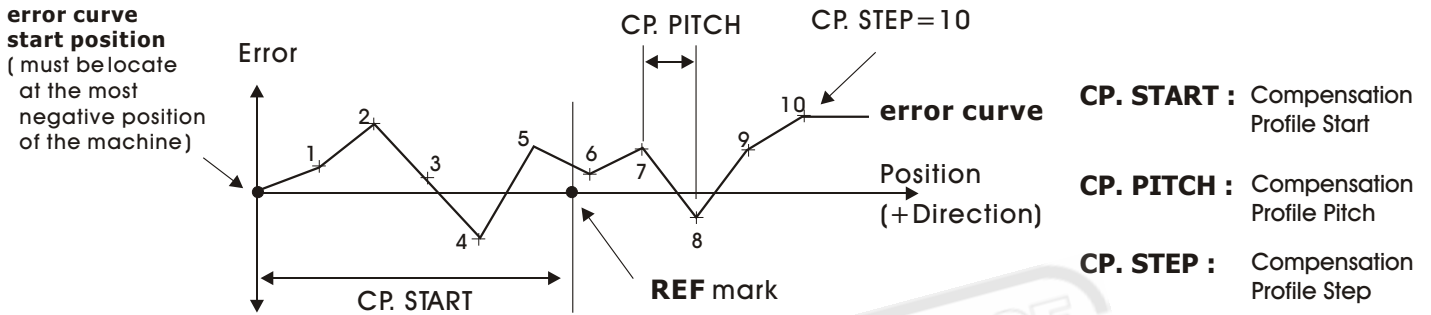

### Operation Procedure

1) Locate the REF zero at ABS coordinate :

swap the readout display to ABS coordinate

Enter into **ref** function

select the **FIND REF** ( find **ref** mark )

## Parameters Setup Procedure - NL ERROR

select the FIND REF ( find ref mark )

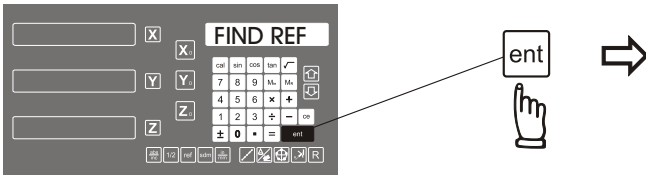

select the Axis

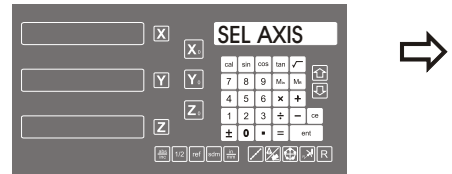

Let's take X as an example

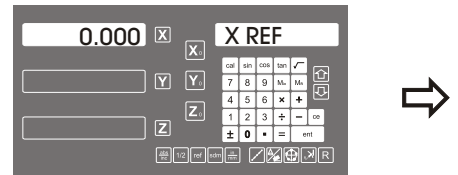
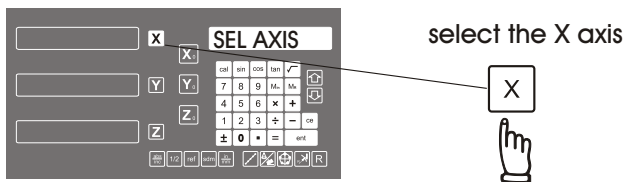

move the machine across the ref mark of the scale until the digits display start run. **Please remember that to move the scale towards the positive direction during finding REF mark.**

after the display digits start run, move the move to X = 0.000, it is the ref mark position of the scale.

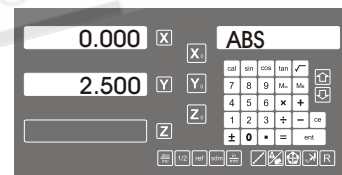
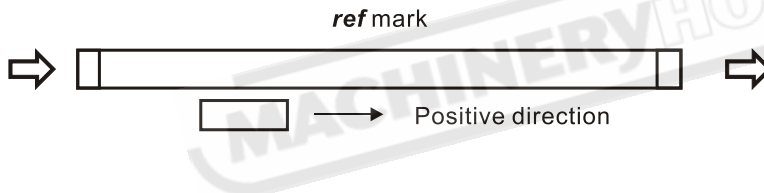

### 2) Locate the CP. START position

The CP. START position is the absolute reference for the internal error compensation calculation, it is the start point of the error curve, to make fast real time compensation calculation possible, the DRO assume all internal error compensation calculation are only in positive direction. Therefore, the CP. START position should be always located in the most negative position of the machine, so that all measured position in the error curve are located in positive direction.

In the example below, we are using a step gauge which has total measurement travel of 300mm as our our measurement standard. The step pitch of the step gauge is 25.000mm  
Our maximum machine travel is 265mm. Therefore,

$$\text{CP. PITCH} = 25.000\text{mm}$$

$$\text{CP. STEP} = 265/25 = 10.6 \text{ steps, since steps must be in integer, then round up to } = 10 \text{ steps.}$$

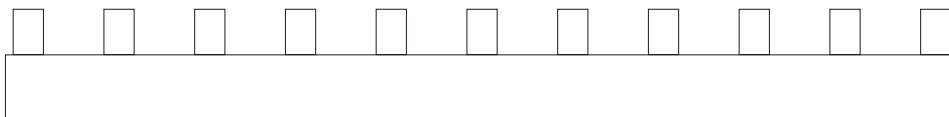

## Parameters Setup Procedure - NL ERROR

Using a dial indicator to locate the most negative position of the step gauge, zero the dial indicator at this position, record down this position as the CP. START position.

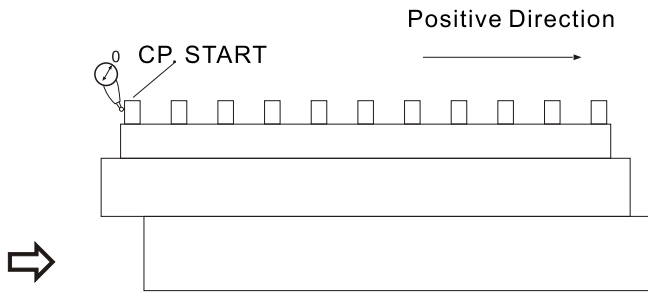

Because the CP. START position always at the most negative position of the machine, therefore, it should always a NEGATIVE value

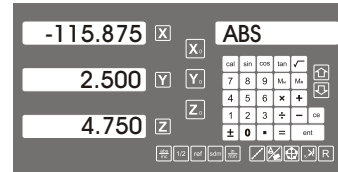

Please record down this position by pen, in this example, the CP. START position = - 115.875

### 3 ) START measure the error, to build up a error curve

To mark the error measurement more easy, swap to INC coordinate and zero at the CP. START position

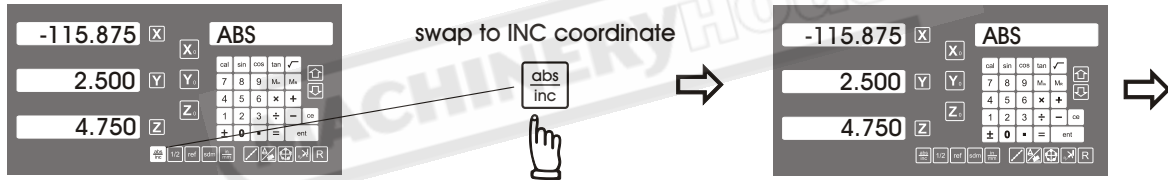

zero the INC coordinate at CP. START position

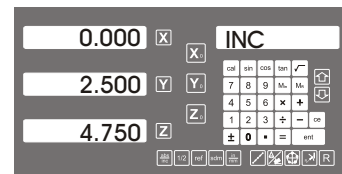

start measure the error by positioning the dial indicator on the step gauge. Take down the display value that shown at the DRO axis display

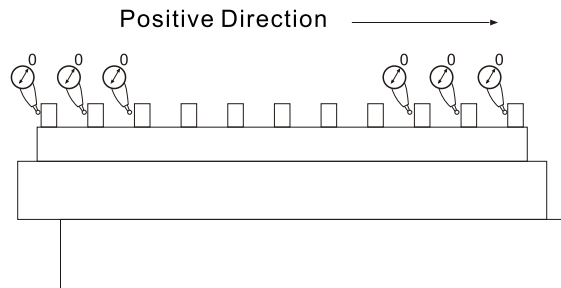

## Parameters Setup Procedure - NL ERROR

**Record down the measured value from the readout and fill up following table**

Standard position	Measured value
25.000	25.008
50.000	50.004
75.000	75.017
100.000	99.995
125.000	125.002
150.000	150.012
175.000	174.997
200.000	199.988
225.000	225.007
250.000	250.015

CP. START = -115.875  
 CP. PITCH = 25.000  
 CP. STEP = 10

### 4) Enter the error curve value into the DRO

switch off the DRO and then switch it on again, press the "ent" to enter to SETUP function

During the start up procedure when the DRO display the Version No. " VER. X? " press "ent" once to enter to the SETUP function

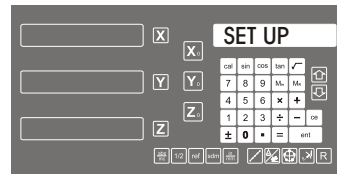
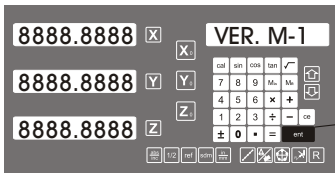

after entered into SETUP function, press the "DOWN" button until "NL ERROR" appear



NL ERROR means Non Linear Error Compensation

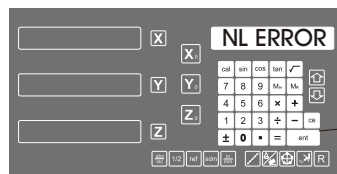

press



to enter into Non Linear Error Compensation Function







---

## Parameters Setup Procedure - NL ERROR

---

after all measured values entered into the DRO, press "ent" to exit the NL ERROR function.



ent



Non Linear Error Compensation Value input completed

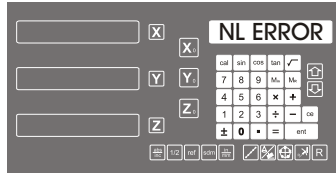

selection done, go to next menu



MACHINERYHOUSE

## Parameters Setup Procedure - Z DIAL

Z DIAL menu is designed to allow user to specifies the Z axis machine increment per dial turn.

This parameter is used only for the two axes ES-8A which intent to use the ARC or R function for XZ/YZ plane arc. This parameter allows a two axis ES-8A to simulate the Z axis movement for ARC or R machining function.

**For three axes ES-8A, this parameter ( Z DIAL ) is not used, no effectiveness.**

For Example :

The Z Dial is the Z axis machine movement per Dial turn. e.g. The Z movement per dial turn is 2.5mm.

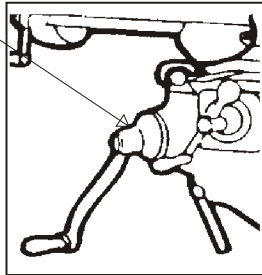

Press **ent** to select the "Z DIAL" selection menu

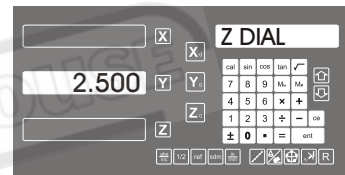
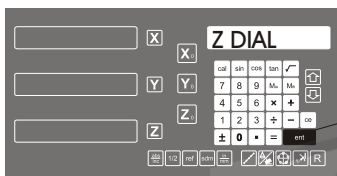

The Z movement per Dial turn is displayed on the DRO

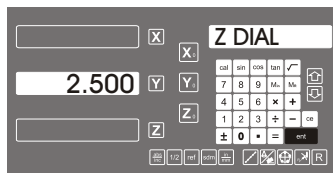
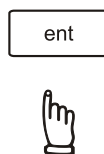
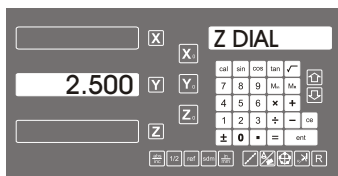
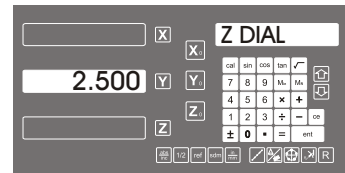
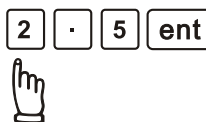
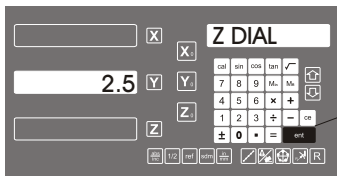

selection done, go to next menu



then press **ent** to exist from "Z DIAL" menu and return to the top level menu

## Parameters Setup Procedure - DIAL INC

Z DIAL menu is designed to allow user to specify the Z axis machine increment per line mark of the Z Dial.

This parameter is used only for the two axes ES-8A which intent to use the ARC or R function for XZ/YZ plane arc. This parameter allows a two axis ES-8A to simulate the Z axis movement for ARC or R machining function.

**For three axes ES-8A, this parameter ( DIAL INC ) is not used, no effectiveness.**

For Example :

The DIAL INC is the Z dial increment per line mark in the Z axis dial of the machine. e.g. The DIAL INC is 0.02mm

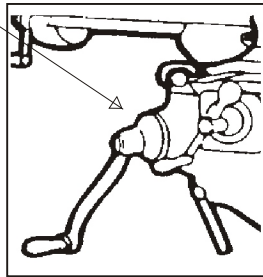

Press **ent** to select the "DIAL INC" selection menu

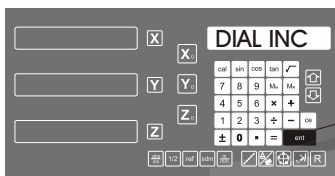

**ent**

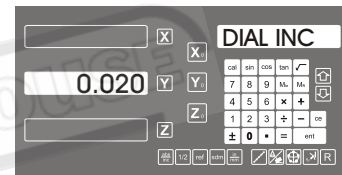

The Z movement per line mark of the Z Dial is displayed on the DRO

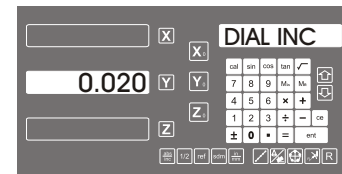
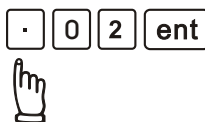
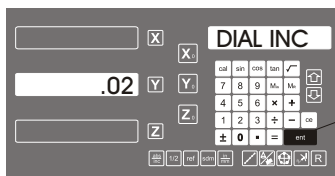

selection done, go to next menu

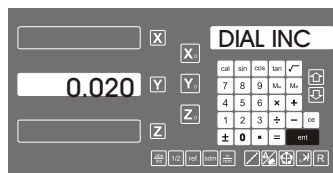
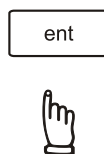
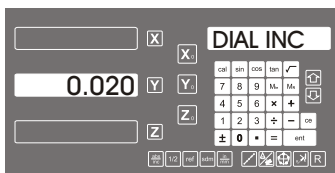

then press **ent** to exist from "Z DIAL" menu and return to the top level menu

## Parameters Setup Procedure - R MODE

R MODE menu is designed to allow user to specify the Z axis interpolation method during the ARC or R function.

**This DRO can offer "MAX CUT" or "Z STEP" for choices.**

If "MAX CUT" selected, the ARC or R function calculation will interpolated the ARC in fixed cutting distance for smoothing ARC machining.

If "S STEP" selected, the ARC or R function calculation will interpolated the ARC in fixed Z axis increment for easier and quick ARC machining.

This parameter is used only in two axes DRO which allows the two axis DRO to simulate the Z axis movement of the ARC machining function.the Z axis machine increment per line mark of the Z Dial.

**For three axes DRO, this parameter ( R MODE ) is not used, no effectiveness.**

Press **ent** to select the "R MODE" selection menu

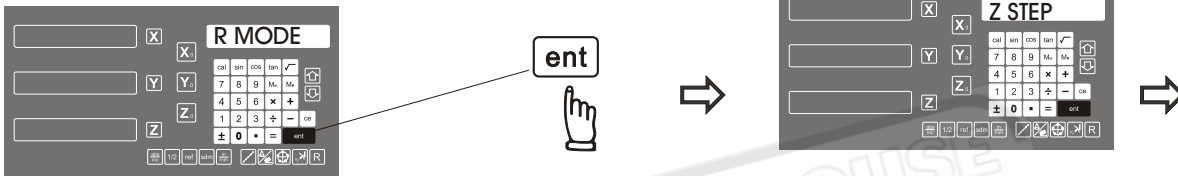

The R mode is displaying on the message window, Z STEP mode is currently using.

The ARC or R function of this DRO has following two method of simulated Z axis interpolation when the DRO have only two axes ( No Z axis 0, they are "Z STEP" and "MAX CUT" as per followings.

### Z STEP

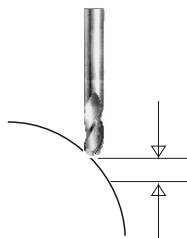

Z STEP mode, the Z axis interpolate in a fixed Z axis increment, it is easier and quicker for ARC machining, however, the machined work piece is not smooth.

### MAX CUT

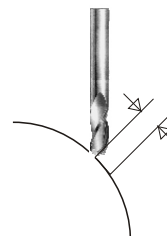

MAX CUT mode, the Z axis interpolate in fixed machine length, it is more time consuming, but the work piece is smoother

# Parameters Setup Procedure - R MODE

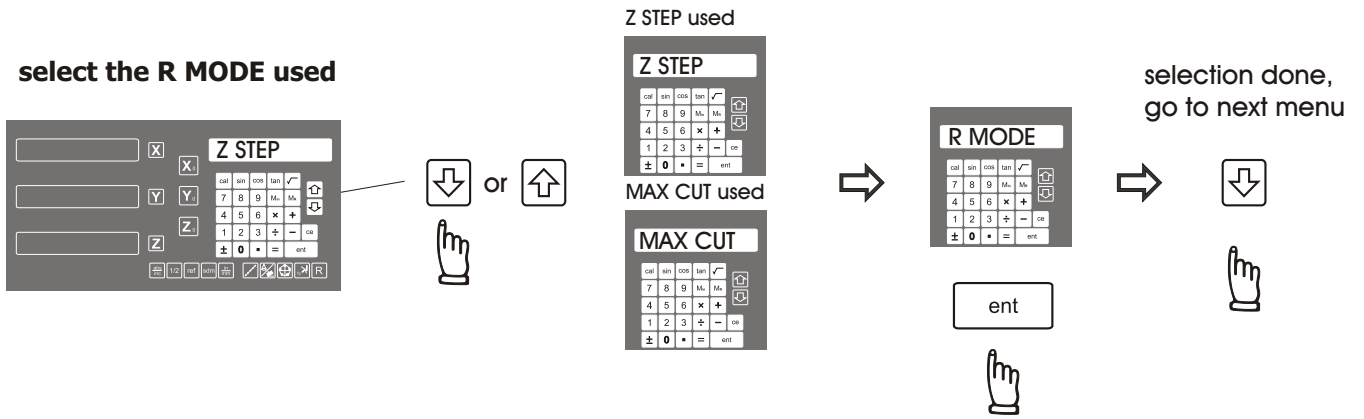

## Parameters Setup Procedure - FLTR. PR & QUIT

FLTR. PR. menu is designed to allow user to specify the filtering range of vibration for the vibration filtering function.

This version of software is offering vibration filtering as one of the standard function in the ES-8A.

This function is used primarily for big or very old machine which the machine structure is not very rigid to resist the vibration when during machining or axis movement.

The bigger the FLTR. PR, the bigger the filtering effect. Slower movement will be observed.

Please notice that the vibration filter won't affect the accuracy of the counting. The measurement accuracy is the same with or without the filter.

Press **ent** to select the "FLTR. PR" selection menu

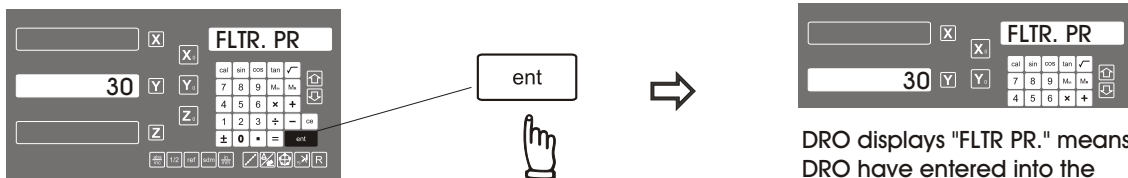

DRO displays "FLTR. PR." means DRO have entered into the FLTR. PR selection menu, user must specify the vibration filtering range to the DRO.

specify the FLTR. PR

For example, we change the FLTR. PR to 60 for higher filtering effect

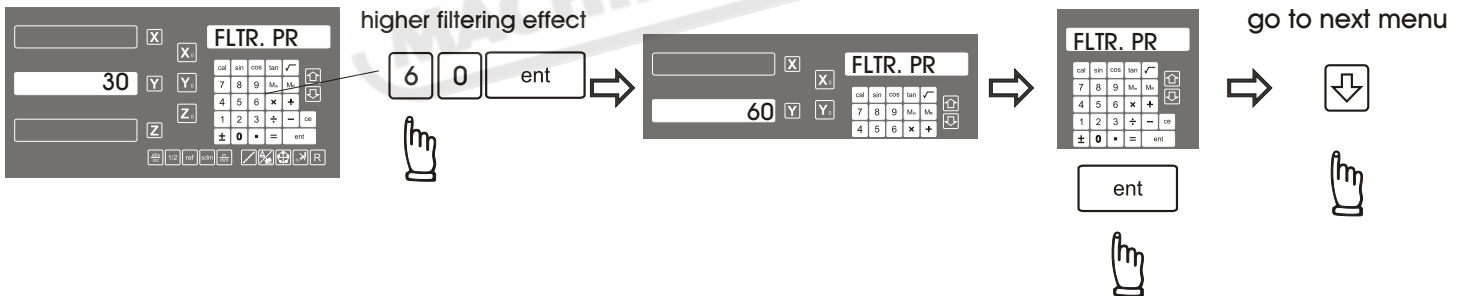

Press **ent** to select the "QUIT" selection menu

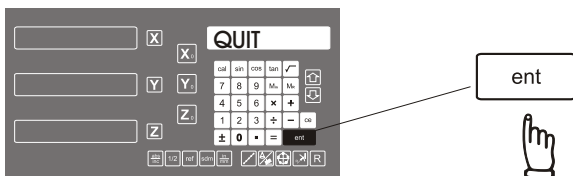

**Please notice that the DRO must be switched off after quit from the SETUP function, otherwise, some of the new parameters may not be able to take effect**